

Instructions for Use



CE
0297

piezomed
pro

M-PH350
M-PM100

Contents

Symbols	4
1. Introduction	7
2. Unpacking	9
3. Scope of delivery	10
4. Safety notes	11
5. Description	17
6. Start-up	21
7. Operation	26
8. Icons	28
9. Error messages	31
10. Hygiene and maintenance	32
General notes	32
Limitations on processing.....	33
Initial treatment at the point of use	34
Manual cleaning.....	35
Manual disinfection	38
Automated cleaning and disinfection	39
Drying	40
Inspection, maintenance and testing	41
Packaging.....	42
Sterilization	43
Storage	45
11. Service	46
12. Accessories, consumables, spare parts and other recommended medical devices by W&H	48
13. Technical data	50

Contents

14. Data on electromagnetic compatibility according to IEC/EN 60601-1-2.....	53
15. Disposal	56
W&H course certificate	59
Explanation of warranty terms	60
Authorized W&H service partners.....	61

Symbols



WARNING!
[risk of injury]



**Sterilizable up to
the stated temperature**



Consult Instructions for Use



ATTENTION!
[to prevent damage occurring]



**Suitable for
ultrasonic bath**



**Do not dispose of with
domestic waste**



**General explanations, without
risk to persons or objects**



**CE marking with identification
number of the Notified Body**



Catalogue number



Medical Device



Manufacturer



Serial number



**Thermo washer
disinfectable**















Date of manufacture



**Data structure in accordance
with Health Industry Bar Code**

Symbols

	Follow Instructions for Use	W	Power (watt)		Type B applied part (not suitable for intracardiac application)
	Batch code		DC – direct current		Do not re-use
	Foot control		This way up		“Der Grüne Punkt” (The Green Dot) trademark of Duales System Deutschland GmbH
V	Electric voltage (volt)		Fragile, handle with care		Trademark of RESY OfW GmbH for identification of recyclable transport and outer packaging of paper and cardboard.
Hz	Frequency (hertz)		Keep dry		Non-sterile

Symbols



DataMatrix Code for product information including UDI (Unique Device Identification)



Instrument changer attachment direction



Use-by date



Do not use if package is damaged



Do not resterilize



Caution! Federal law restricts this device to sale by or on the order of a physician, dentist, veterinarian or with the descriptive designation of any other practitioner licensed by the law of the State in which the practitioner practices to use or order the use of the device.



Keep away from sunlight



Temperature limitation



Humidity limitation



MEDICAL – GENERAL MEDICAL EQUIPMENT AS TO ELECTRICAL SHOCK, FIRE AND MECHANICAL HAZARDS ONLY IN ACCORDANCE WITH ANSI/AAMI ES60601-1:2005/(R)2012 + A1:2012 + C1:2009/(R)2012 + A2:2010/(R)2012, ANSI/AAMI ES60601-1:2005/A2:2021, CAN/CSA-C22.2 No. 60601-1:14, CAN/CSA-C22.2 No. 60601-1:14/A2:22, IEC 80601-2-60:2019. 25UX – Control No.



Sterilized using irradiation



Single sterile barrier system

1. Introduction



For your safety and the safety of your patients

These Instructions for Use explain how to use your medical device. However, we must also warn against possible hazardous situations. Your safety, the safety of your team and, of course, the safety of your patients, are of paramount importance to us.



Observe the safety notes.

Intended use

The piezoelectric surgical system is indicated for: osteotomies, osteoplasties, drilling and shaping of hard tissue. Including: ENT-surgery, CMF-surgery, hand and foot surgery, plastic and reconstructive surgery.



Misuse may damage the medical device and hence cause risks and hazards for patient, user and third parties.



Qualifications of the user

Only suitably qualified medical, technical and specialist trained staff may use the medical device. We have based our development and design of the medical device on the physician target group.

Introduction

Responsibility of the manufacturer

The manufacturer can only accept responsibility for the safety, reliability and performance of the medical device when it is used in compliance with the following directions:

- > The medical device must be used in accordance with these Instructions for Use.
- > The medical device has no components that can be repaired by the user.
- > Modifications or repairs must only be undertaken by an authorized W&H service partner (see page 61).
- > The electrical installation at the premises must comply with the regulations laid out in IEC 60364-7-710 (“Installation of electrical equipment in rooms used for medical purposes”) or with the regulations applicable in your country.
- > Unauthorized opening of the medical device invalidates all claims under warranty and any other claims.



Skilled application

The medical device is intended only for skilled application according to the intended use as well as in compliance with the valid health and safety at work regulations, the valid accident prevention regulations and in compliance with these Instructions for Use. The medical device should be prepared for use and maintained by staff who have been trained in procedures for infection control, personal safety and patient safety. Improper use (e.g., through poor hygiene and maintenance), unauthorized assembly, modification or repair to the medical device, non-compliance with our instructions or the use of accessories and spare parts which are not approved by W&H, invalidates all claims under warranty and any other claims.



Any serious incident that has occurred in relation to the medical device should be reported to the manufacturer and the competent authority!

2. Unpacking

Control unit M-PM100

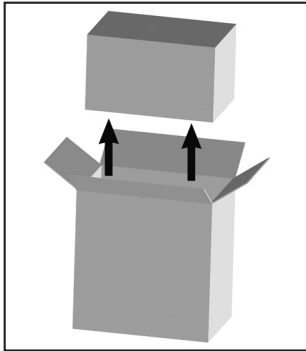

- ❶ Remove the carton.

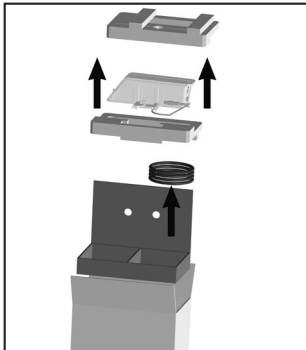

- ❷ Lift out the Instructions for Use, control unit and mains cable.

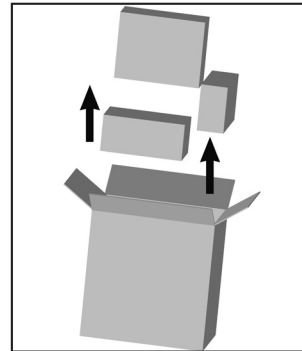

- ❸ Remove the packaging and remove the power supply, irrigation tubing set and accessories.

W&H packaging is environmentally friendly and can be disposed of by industrial recycling companies. However, we recommend that you keep the original packaging.

3. Scope of delivery

Control unit	M-PM100 30500000
Mains cable country-specific	X

Optional included in set

REF 30501000	Handpiece M-PH350 with 3,5 m cable
REF 00636901	Nozzle cleaner
REF 30264000	Foot control S-NW
REF 30285000	Foot control S-N2
REF 08132760	Instrument changer M-IC350
REF 07883900	Power supply
REF 08174800	Irrigation tubing set 3,8 m (6 pcs disposable)
REF 30387000	Amadeo control unit M-UK1023 (230 V)
REF 30388000	Amadeo control unit M-UK1015 (120 V)
REF 30389000	Amadeo control unit M-UK1010 (100 V)
REF 30393000	Amadeo motor M-MH40 with 3,5 m cable
REF 04005900	Amadeo stand

4. Safety notes



- > Before using the medical device for the first time, store it at room temperature for 24 hours.
- > Check the medical device for damage and loose parts each time before using.
- > Do not operate the medical device if it is damaged.
- > Only put the medical device into operation when the handpiece cap is screwed on.
- > Perform a test run each time before using.
- > Avoid overheating at the treatment site.
- > The responsibility for the use and timely shutdown of the system lies with the user.
- > Ensure that it is possible to complete the operation safely should the units or instruments fail.
- > Never touch the patient and the electrical contacts on the medical device simultaneously.
- > Make sure that no computer viruses are transferred to the control unit by an external data medium (USB stick).
- > The medical device is not approved for operation in potentially explosive atmospheres.
- > The medical device is not approved for operation in oxygen rich environment.



- > Do not twist or kink the cable! Do not coil it too tightly!

Safety notes



Power failure

In the event of a power failure or if the control unit is switched off, the last values set are saved and re-activated on power-up.

System failure

A total system failure does not constitute a critical fault.



Mains cable/Power supply

- > Only use the mains cable/power supply supplied.
 - > Plug the mains cable only into a power socket with protective contact.
- Disconnect the medical device in dangerous situations from the power supply.**
- > Pull the power supply out of the socket.



The medical device is classed as “conventional equipment” (closed equipment without protection against the ingress of water).



Foot control

Follow the directions and safety notes in the Instructions for Use of the foot control.



Foot control S-NW

Keep the ORANGE button pressed to switch between the control units/applications.

Safety notes

Control unit



Risks due to electromagnetic fields

The functionality of active implantable medical devices (AIMD) (e.g. cardiac pacemaker, ICD) can be affected by electric, magnetic and electromagnetic fields.

- > Find out if the patient has active implantable medical devices (AIMD) before using the medical device and inform about the risks.

Handpiece



Risks due to electromagnetic fields

This medical device is suitable for use on patients with cardiac pacemakers.

The functionality of other active implantable medical devices (AIMD) (e.g. ICD) can be affected by electric, magnetic and electromagnetic fields.

- > Find out if the patient has other active implantable medical devices (AIMD) before using the medical device and inform about the risks.

Safety notes

Coolant supply



The medical device is designed for use with physiological saline solution.



- > Always ensure the correct operating conditions and cooling function.
- > Use only suitable coolants and follow the manufacturer's medical data and instructions.
- > In case of coolant supply failure, the medical device must be stopped immediately.
- > Only use an Irrigation tubing set approved by W&H or accessories approved by W&H.
- > Make sure that the coolant filling function has been carried out prior to every application.

Sterile medical devices



- > Only use the medical device if the sterile packaging is undamaged and unopened.
- > Note the expiration date.
- > Replace the medical device immediately after every treatment.
- > Dispose of the medical device in accordance with the applicable regulations.

Change application



When changing the application an acoustic signal sounds (risk of injury).

Safety notes

Intermittent periodic duty S3 (60 s ON / 30 s OFF)



The medical device is designed for intermittent periodic duty S3 with 60 seconds ON and 30 seconds OFF. If the specified operating mode is observed no overheating of the system and therefore no injury to the patients, users or third parties arises. The responsibility for the use and timely shutdown of the system lies with the user.

Instruments



- > Only use instruments approved by W&H and the associated instrument changer.
- > Ensure that the original shape of the instrument is not changed (e.g. by dropping).
- > Instruments must not be bent back to shape or reground.
- > Only insert the instrument when the handpiece is at rest.
- > Never touch the instrument when vibrating.
- > Remove the instrument from the handpiece after every treatment and place it in the instrument stand (provides protection against injury and infection).
- > Ensure there is sufficient coolant directly at the treatment site.
- > Keep the handpiece moving at all times when operating the instrument.
- > Do not exert too much pressure on the instrument. This can cause the instrument to heat up or break, resulting in injury to the patient.
- > Do not make any levering motions with the instrument.
- > Never let the instrument run freely without coolant.

Safety notes

Hygiene and maintenance prior to initial use

-  > Clean the control unit.
- > Clean and disinfect the handpiece with cable, the universal support, the instruments, the instrument changer and the stand.
- > Sterilize the the handpiece with cable, the universal support, the instruments and the instrument changer.

Test run

 Do not hold the handpiece with cable at eye level!

- > Attach the handpiece with cable to the control unit.
- > Insert the instrument.
- > Put the medical device into operation.

 In the event of operating malfunctions (e.g. vibrations, unusual noises or overheating) stop the medical device immediately and contact an authorized W&H service partner.

5. Description

Control unit M-PM100

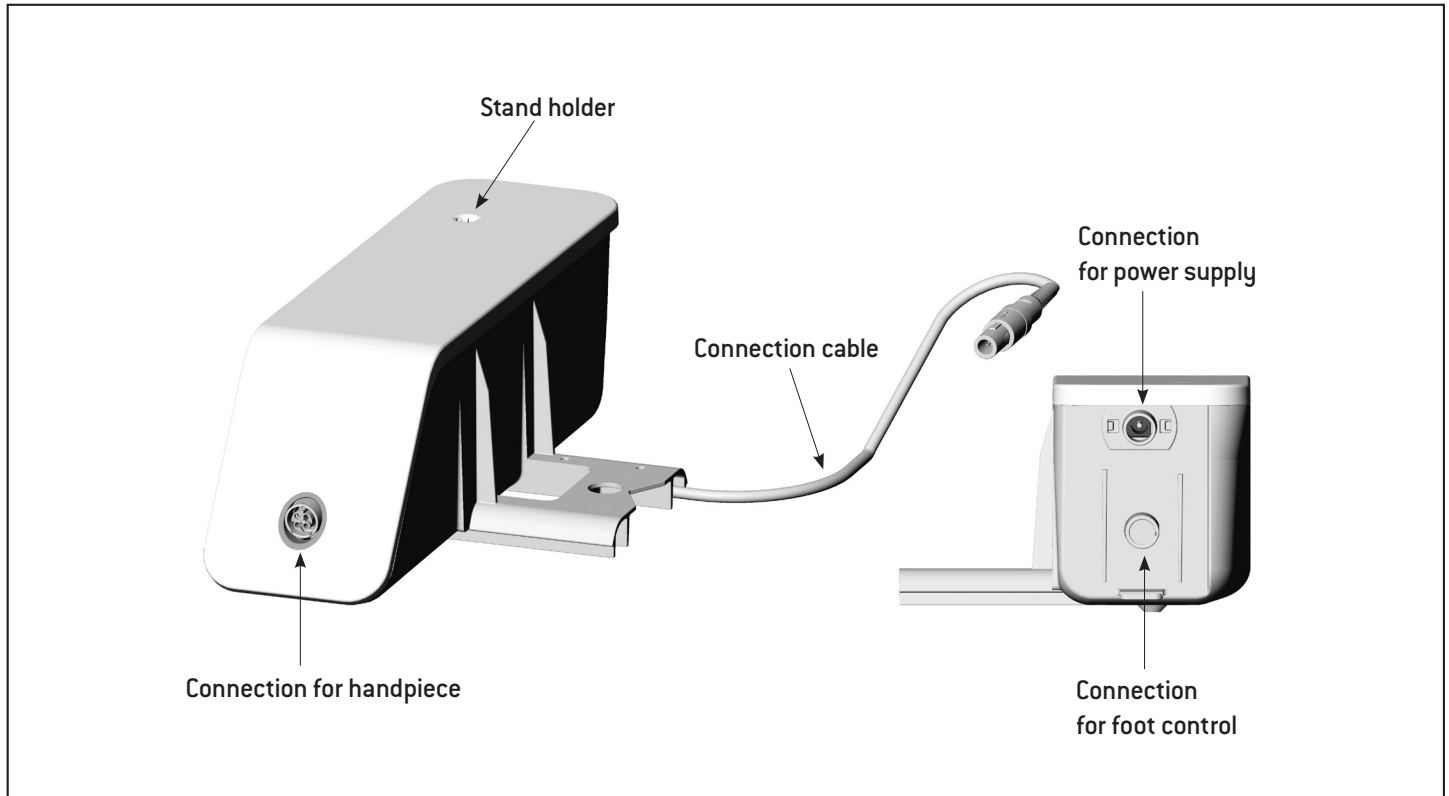

Description

Handpiece with cable M-PH350

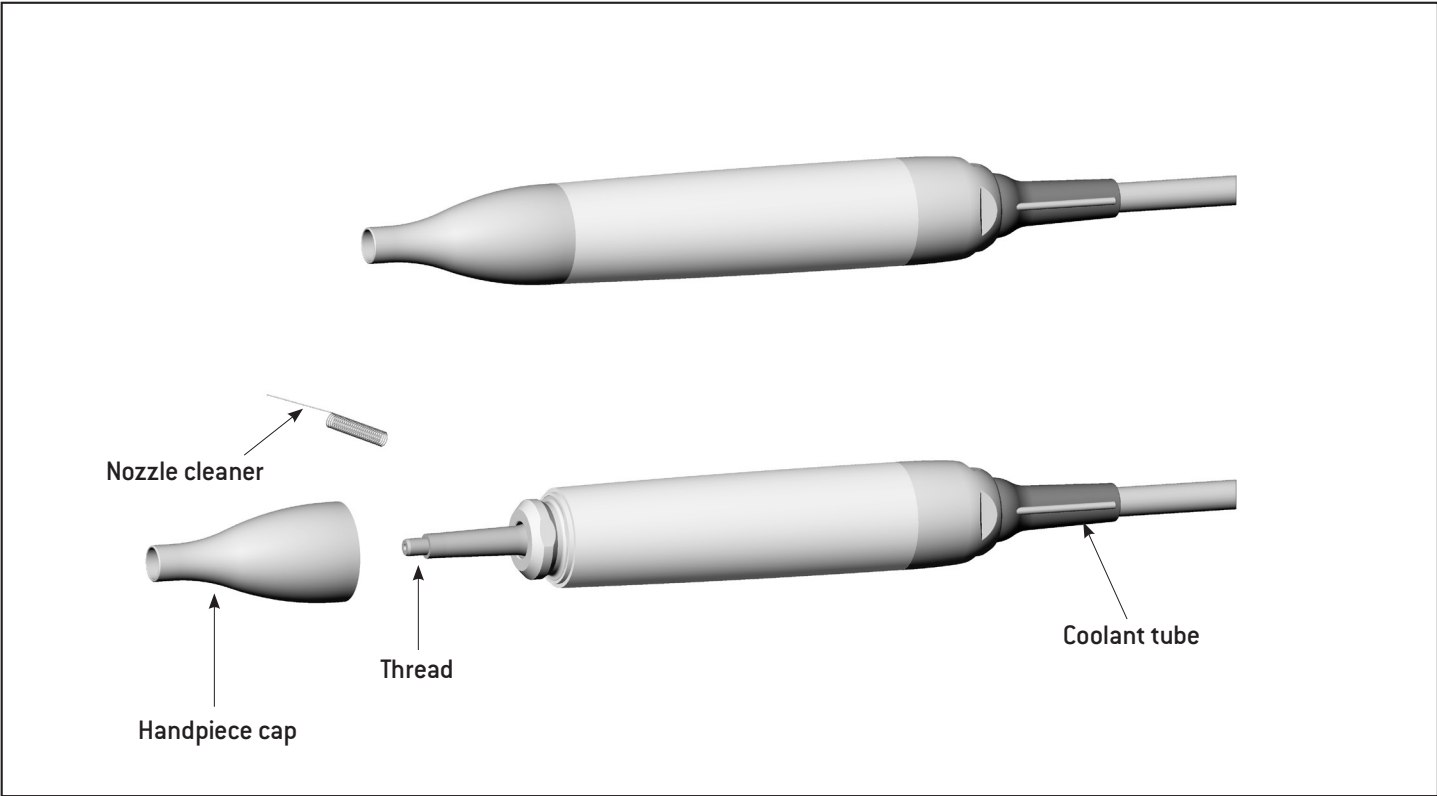

Description

Foot control S-N2 / S-NW

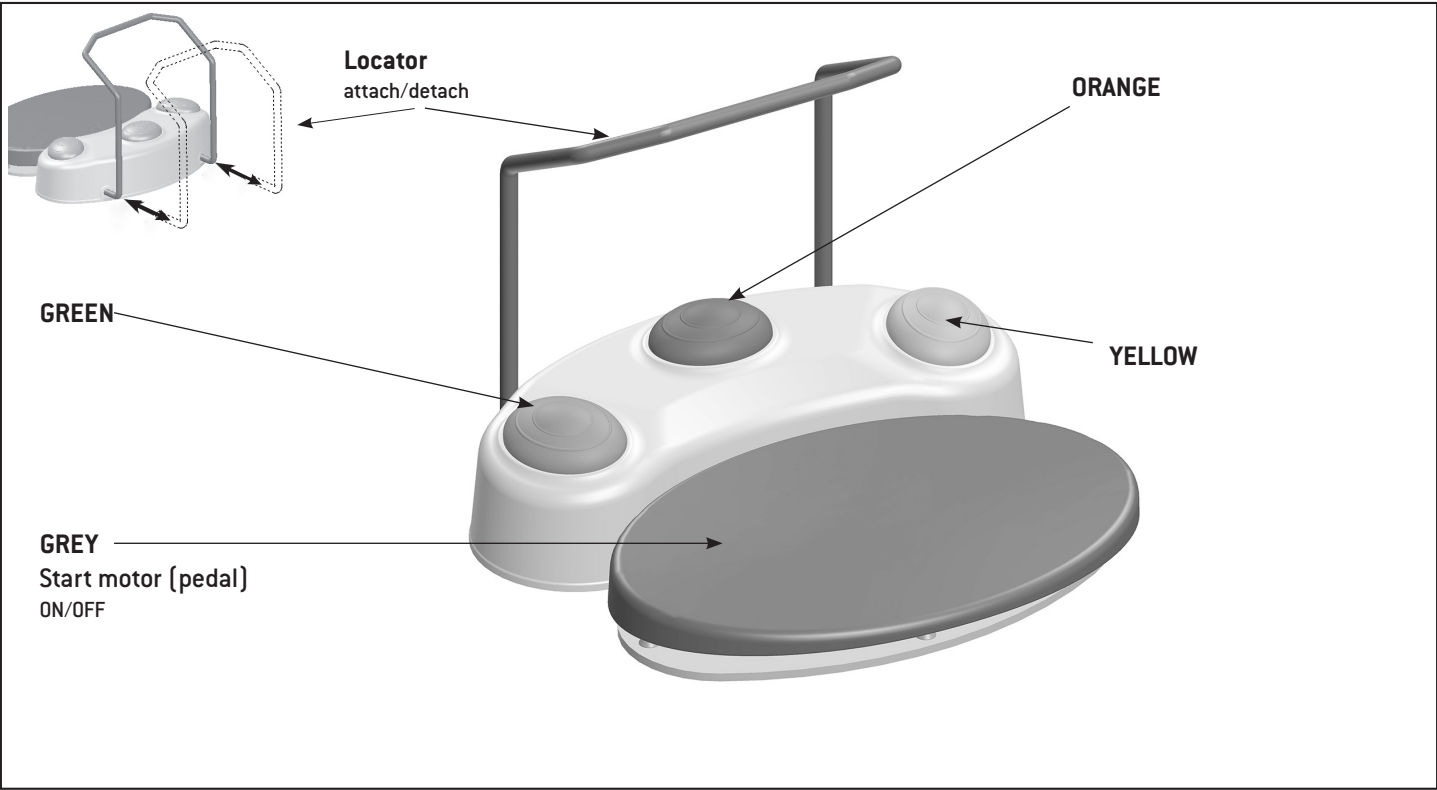

ORANGE



S-NW: Switching between multiple control units

Press the ORANGE button for 3 seconds.



S-NW: Change application

Press the ORANGE button for 3 seconds until an acoustic signal sounds.

S-N2: Change application

Press the ORANGE button for 3 seconds until an acoustic signal sounds.

GREEN

Press the green button to change the coolant volume in steps of 20%

Press and hold the GREEN button to activate the coolant filling function.

YELLOW

Boost function

Press and hold the YELLOW button to activate the boost function.

The boost function increases the power to 100% during operation, regardless of the value set on the display.

6. Start-up



Place the medical device on a flat level surface.



Ensure that the medical device can be disconnected from the power supply at any time.

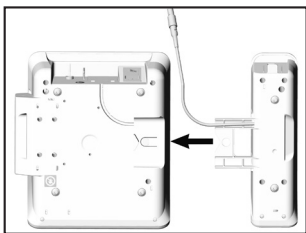

- ❶ Attach the control unit until it engages.

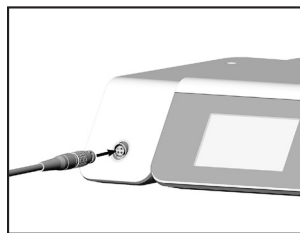

- ❸ Connect handpiece cable.
Pay attention to the positioning!

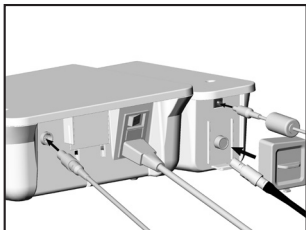

- ❷ Connect the connection cable to the M-UK10xx foot control connection. Connect the power supply, foot control or dongle to the M-PM100.

Pay attention to the positioning!

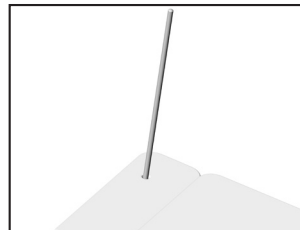

- ❹ Insert the stand.
Pay attention to the positioning!

Start-up

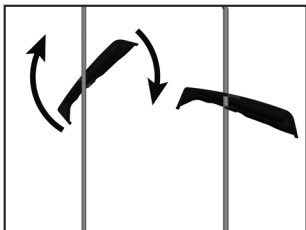

- 5 Attach the universal support and lock it.

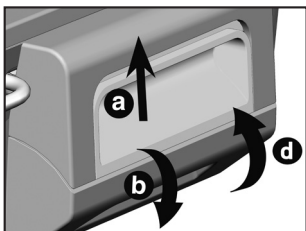

- 6 Insert the irrigation tubing.

> Open the pump cover [a, b].

> Insert the irrigation tubing [c].

> Close the pump cover [d].

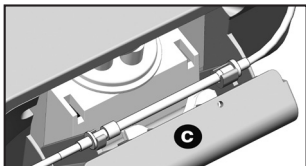

Start-up

Insert/remove instruments

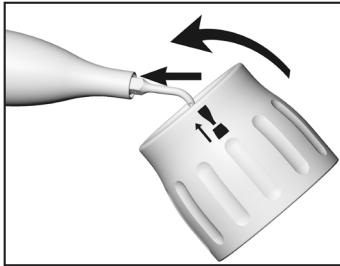

- 1 Screw the instrument onto the thread of the handpiece by hand. Attach the instrument changer to the instrument.

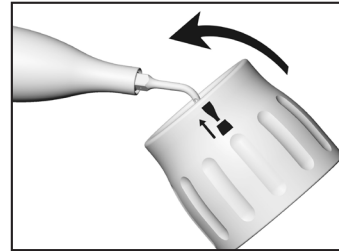

- 1 Attach the instrument changer to the instrument.

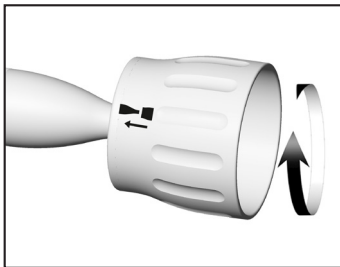

- 2 Turn the instrument changer until it snaps into place.

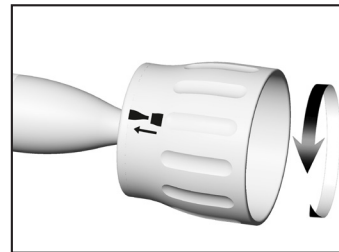

- 2 Unscrew the instrument with the instrument changer.

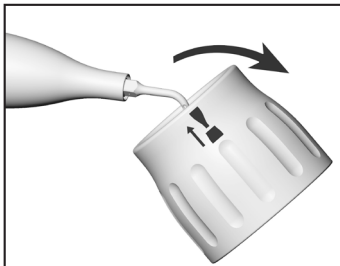

- 3 Carefully pull off the instrument changer.



Verify full engagement.



Keep the instrument in the stand until a hygiene and maintenance process is carried out.

Start-up

Control unit switching on and off

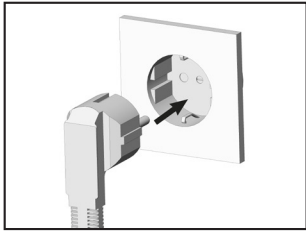

- 1 Plug the mains cable/power supply into an earthed power socket.

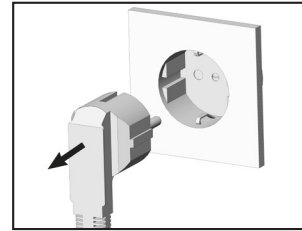

- 1 Pull the power plug out of the socket.

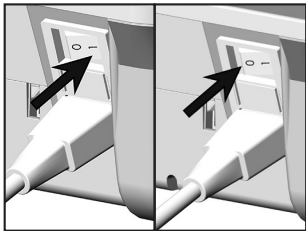

- 2 Switch on/off the control unit at the power switch.



Ensure that the M-PM100 is connected to the power supply before switching on the control unit at the power switch.



Make sure that the coolant filling function has been carried out prior to every application.



Coolant filling function



Start the coolant filling function by confirming the entry.



The coolant filling functions lasts for 15 seconds.

Press any button on the display or the foot control to stop the coolant filling function.

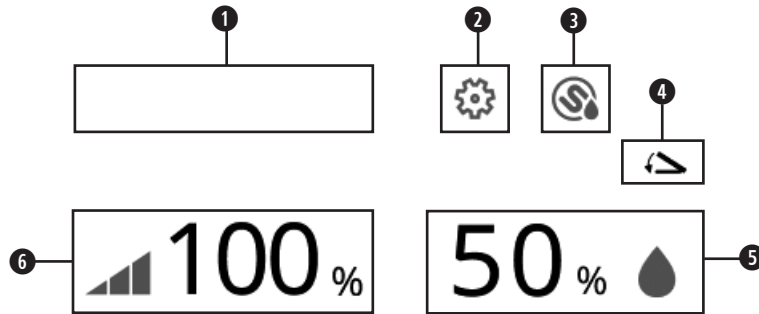

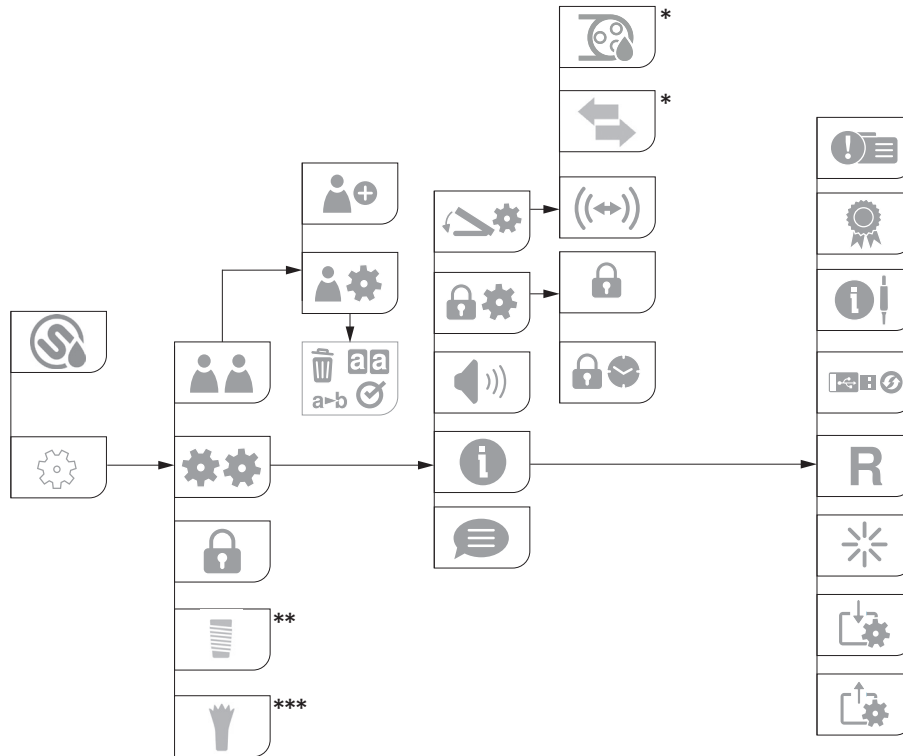

①	Application area
②	Setup
③	Coolant filling function
④	Foot control
⑤	Coolant volume
⑥	Power



* Only visible when using the foot control S-NW.

** Visible in Piezo mode / *** visible in Amadeo mode

8. Icons

 **User**
 An activated user cannot be deleted

 **Add user**

 **Manage user**
User settings: Copy, Rename, Activate, Delete

 **Confirm/save**

 **Switch to next screen**

 **Set foot control**

 **Pairing S-NW**

 **Foot control ON/OFF**

 **System**

 **Amadeo mode**
> Switch from Piezo mode to Amadeo mode

 **Piezo mode**
> Switch from Amadeo mode to Piezo mode

 **Coolant filling function**

















 **Screen lock**
> Activating/deactivating

 **Set screen lock**
> Activating/deactivating
> Interval

 **Interval time**
> Select time

 **SOUND**
> Activating/deactivating

Icons

	Language > Select		Import user settings
	Device info		Export user settings
	Service		Change application > Activating/deactivating  Switch only between Amadeo/Piezo mode
	Licenes GPL: GNU General Public License LGPL: GNU Lesser General Public License		Change application OFF
	Module info		Pump run no-scaler > Activating/deactivating  Pump runs without attached handpiece/instrument
	Reset		Pump run no-scaler OFF
	Software Update		
	Reset		

Icons



Setting selected



black = Information
green = Information with selection option



red = error message, work cannot be continued
orange = error message, work can be continued



red = replace batteries



Foot control S-NW









Foot control S-N2



Reduce/increase parameters

- > pressing minus/plus
- > moving the slider
- > pressing onto the line of the slider at any position

9. Error messages

Icon	Description of error	Solution
	WARNING FOOT CONTROL	<ul style="list-style-type: none"> > Check plug-in connection of foot control > Check the plug-in connection of the dongle
	WARNING SWITCH COOLANT SUPPLY	<ul style="list-style-type: none"> > Ensure the coolant supply for the selected applied part > Press any button on the display or the foot control to stop the coolant filling function.
	WARNING SURGERY SCALER	<ul style="list-style-type: none"> > Check the plug contacts of the handpiece > Allow handpiece to cool for at least 10 minutes
	WARNING NO SCALER DETECTED	<ul style="list-style-type: none"> > Check the plug contacts of the handpiece > Insert the instrument > Check that the instrument is firmly held
	SYSTEM ERROR	<ul style="list-style-type: none"> > Switch the control unit off and back on again <p> If the error message appears again, contact an authorized service partner immediately.</p>

- > If the error messages described cannot be resolved, a check by an authorized W&H service partner is required.
- > In case of a total system failure, switch the dental unit off and on again.



Follow your local and national laws, directives, standards and guidelines for cleaning, disinfection and sterilization.



The instruments can be reprocessed in the instrument stand (REF 08174900).



- > Wear protective clothing, safety glasses, face mask and gloves.
- > Use only oil-free, filtered compressed air with a maximum operating pressure of 3 bar for manual drying.



- > The handpiece with cable must not be disassembled.



Cleaning agents and disinfectants

- > Read the notes, follow the instructions and heed the warnings provided by the manufacturers of cleaning agents and/or disinfectants.
- > Use only detergents which are intended for cleaning and/or disinfecting medical devices made of metal and plastic.
- > It is imperative to comply with the concentrations and exposure times specified by the manufacturer of the disinfectant.
- > Use disinfectants which have been tested and found effective by, for example: the Verbund für Angewandte Hygiene e.V. (VAH = Association for Applied Hygiene), the Österreichischen Gesellschaft für Hygiene, Mikrobiologie und Präventivmedizin (ÖGHMP = Austrian Society for Hygiene, Microbiology and Preventive Medicine), the Food and Drug Administration (FDA) or the U.S. Environmental Protection Agency (EPA).

The user is responsible for validating its process if the specified cleaning agents and disinfectants are not available.



The product lifetime and the medical device's ability to operate correctly are mainly determined by mechanical stress during use and chemical influences due to processing.

- > Send worn or damaged medical devices and/or medical devices with material changes to an authorized W&H service partner.



Processing cycles

- > We recommend a regular service for the W&H medical device after 300 processing cycles or one year.
- > We recommend to replace the instrument changer after 300 processing cycles.
- > We recommend checking the instruments for material wear after 10 reprocessing cycles.

- 
- > Clean the control unit immediately after every treatment.
 - > Clean the handpiece with cable immediately after every treatment, to flush out liquid (e.g., blood, saliva etc.) and to prevent settling on the internal parts.
 - > Operate the coolant filling function for at least 10 seconds.
 - > Ensure that all outlets are rinsed out.

- 
- > Remove the instrument.
 - > Remove the handpiece with cable.
 - > Wipe the entire surface of the handpiece with cable, the universal support and the stand with disinfectant.



Note that the disinfectant used during pre-treatment is only for personal protection and cannot replace the disinfection step after cleaning.

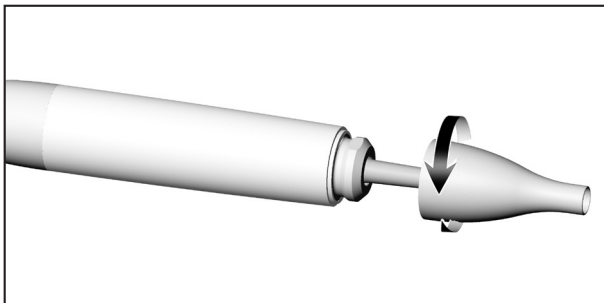

Disassembling the handpiece with cable

- 1 Unscrew the handpiece cap.

Handpiece with cable, instruments, instrument changer, universal support, stand

 Do not place the handpiece with cable, the instrument changer, the universal support and the stand in liquid disinfectant or in an ultrasonic bath.

- > Clean the handpiece with cable, the instruments, the instrument changer, the universal support and the stand under running tap water [$< 35^{\circ}\text{C}$ / $< 95^{\circ}\text{F}$].
- > Rinse and brush off all internal and external surfaces.
- > Remove any liquid residues using compressed air.

Instruments



Clean and disinfect diamond coated instruments in an ultrasonic bath.



Evidence of the medical device's basic suitability for effective manual cleaning and disinfection was provided by an independent test laboratory using the "Bandelin Type RK 100CC" ultrasonic bath and the cleaning agent and disinfectant "StammopurDR8" (DR H Stamm, Berlin) and "CaviCide™" (Metrex).

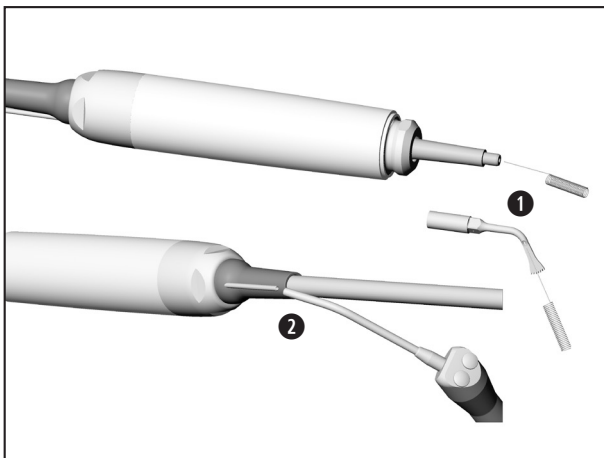

Cleaning of the coolant tubes / spray nozzles



Clean and disinfect the nozzle cleaner in an ultrasonic bath and/or in the washer disinfectant.

- 1 Clean outlets carefully with the nozzle cleaner to remove dirt and deposits.
- 2 Blow through the coolant tube and coolant outlets using compressed air.



In case of blocked coolant outlets or coolant tubes contact an authorized W&H service partner.

Control unit





Do not immerse the control unit in water or clean it under running water.



Evidence of the medical device's basic suitability for effective manual cleaning was provided by an independent test laboratory using tap water < 35°C and towels/cloth »WIPEX[®] WET DESI premium« (NORDVLIES GmbH, Bargteheide).

Control unit, universal support, stand, handpiece with cable, instruments, instrument changer

-  W&H recommends wiping down with disinfectant.

-  Evidence of the basic suitability of the control unit, the universal support, the stand, the handpiece with cable, the instruments and the instrument changer for effective manual disinfection was provided by an independent test laboratory using the disinfectants “mikrozyd® AF wipes” (Schülke & Mayr GmbH, Norderstedt) and “CaviWipes™” (Metrex).

Universal support, stand, handpiece with cable, instruments, instrument changer



W&H recommends automated cleaning and disinfection using a washer disinfector (WD).

- > Read the notes, follow the instructions and heed the warnings provided by the manufacturers of washer disinfectors, cleaning agents and/or disinfectants and washer disinfector adaptors.

Instruments and coolant tube

- > Only use approved and validated adaptors for products with voids for your washer disinfector.



The control unit is not approved for automated cleaning and disinfection.



Evidence of the basic suitability of the universal support, the stand, the handpiece with cable, the instruments and the instrument changer for effective automated disinfection was provided by an independent test laboratory using the “Miele PG 8582 CD” washer disinfector (Miele & Cie. KG, Gütersloh) and the “Dr. Weigert neodisher® MediClean forte” cleaning agent (Dr. Weigert GmbH & Co. KG, Hamburg) according to ISO 15883.

- > Cleaning at 55 °C (131°F) – 5 minutes
- > Disinfection at 93 °C (200°F) – 5 minutes

Universal support, stand, handpiece with cable, instruments, instrument changer

-  > Ensure that the universal support, the stand, the handpiece with cable, the instruments and the instrument changer are completely dry after cleaning and disinfection.
- > Remove liquid residues using compressed air.

Universal support, stand, handpiece with cable, instruments, instrument changer



- > Check the universal support, the stand, the handpiece with cable, the instruments and the instrument changer after cleaning and disinfection for damage, visible residual soiling and surface changes.
- > Reprocess the universal support, the stand, the handpiece with cable, the instruments and the instrument changer that are still soiled.
- > Sterilize the universal support, the handpiece with cable, the instruments and the instrument changer support following cleaning and disinfection.

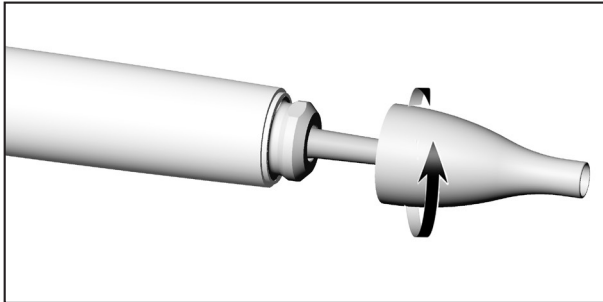

Reassembling the handpiece with cable



Reassemble the medical device following cleaning and disinfection.

- 1 Screw on the handpiece cap.

Universal support, handpiece with cable, instruments, instrument changer



Pack the universal support, the handpiece with cable, the instruments and the instrument changer in sterilization packages that meet the following requirements:

- > The sterilization procedure must meet the applicable standards in respect of quality and use and must be suitable for the sterilization method.
- > The sterilization package must be large enough for the sterilization goods.
- > The loading sterilization package must not be under tension.

Universal support, handpiece with cable, instruments, instrument changer



W&H recommends sterilization according to EN 13060, EN 285 or ANSI/AAMI ST55.



- > Read the notes, follow the instructions and heed the warnings provided by the manufacturers of steam sterilizers.
- > The program selected must be suitable for the universal support, the handpiece with cable, the instruments and the instrument changer.

Recommended sterilization procedures

Universal support, handpiece with cable, instruments, instrument changer

- > “Dynamic-air-removal prevacuum cycle” (type B) / “Steam-flush pressure-pulse cycle” (type S)*/**
134°C (273°F) for at least 3 minutes, 132°C (270°F) for at least 4 minutes
- > Maximum sterilization temperature 135°C (275°F)

Universal support

- > “Gravity-displacement cycle” (type N)**
121°C (250°F) for at least 30 minutes

 Evidence of the basic suitability of the universal support, the handpiece with cable, the instruments and the instrument changer for effective sterilization was provided by an independent test laboratory using the LISA 517 B17L* steam sterilizer (W&H Sterilization S.r.l., Brusaporto (BG)), the Systec VE-150* steam sterilizer (Systec) and the CertoClav MultiControl MC2-S09S273** steam sterilizer (CertoClav GmbH, Traun).

Universal support, handpiece with cable, instruments, instrument changer

“Dynamic-air-removal prevacuum cycle” (type B): 134°C (273°F) – 3 minutes*, 132°C (270°F) – 4 minutes*/**

“Steam-flush pressure-pulse cycle” (type S): 134°C (273°F) – 3 minutes*, 132°C (270°F) – 4 minutes*/**

Universal support

“Gravity-displacement cycle” (type N): 121°C (250°F) – 30 minutes**

Drying times:

Universal support, handpiece with cable, instruments, instrument changer

“Dynamic-air-removal prevacuum cycle” (type B): 132°C (270°F) – 30 minutes**

“Steam-flush pressure-pulse cycle” (type S): 132°C (270°F) – 30 minutes**

Universal support

“Gravity-displacement cycle” (type N): 121°C (250°F) – 30 minutes**

* EN 13060, EN 285, ISO 17665

** ANSI/AAMI ST55, ANSI/AAMI ST79

Universal support, handpiece with cable, instruments, instrument changer



- > Store sterile goods dust-free and dry.
- > The shelf life of the sterile goods depends on the storage conditions and type of packaging.

11. Service



Periodic inspection

Regular periodic inspection of the function and safety of the medical device is necessary and should be carried out at least once every three years, unless shorter intervals are prescribed by law.

The periodic inspection covers the complete medical device and must only be performed by an authorized service partner.

Service

Repairs and returns

In the event of operating malfunctions immediately contact an authorized W&H service partner.
Repairs and maintenance work must only be undertaken by an authorized W&H service partner.



> Ensure that the medical device has been completely processed before returning it.



> Always return equipment in the original packaging.

> Do not coil the cable around the handpiece and do not twist or kink the handpiece cable. (Risk of damage)

12. Accessories, consumables, spare parts and other recommended medical devices by W&H



Use only original W&H accessories and spare parts or accessories approved by W&H!
Suppliers: W&H partners (Link: <https://www.wh.com>)

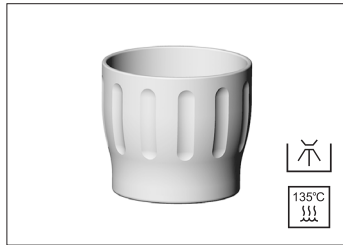

08132760

Instrument changer
M-IC350

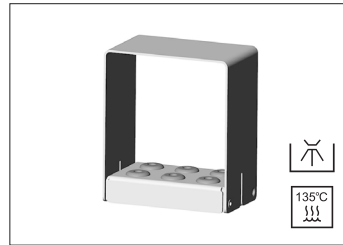

08174900

Instrument stand

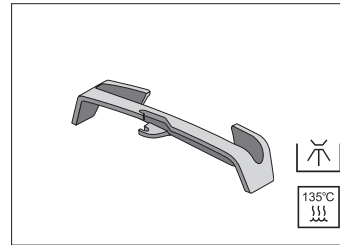

07721800

Universal support

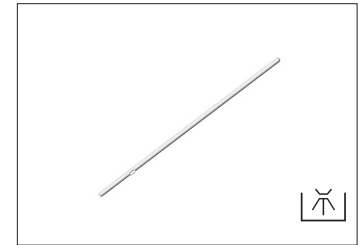

08067690

Stand

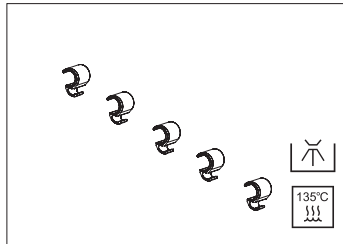

08046870

Clips (5 pcs)

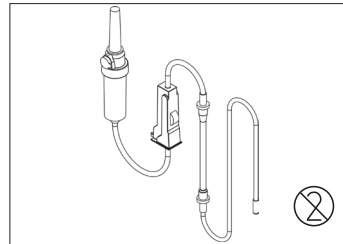

08174800

Irrigation tubing set 3,8 m
(6 pcs, disposable item)

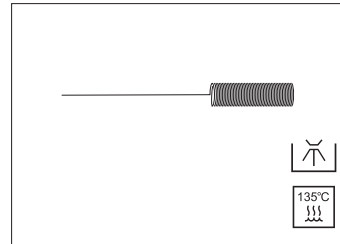

00636901

Nozzle cleaner

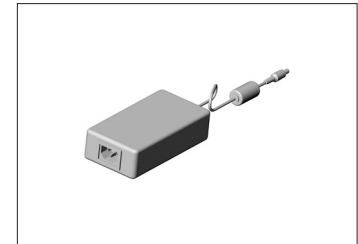

07883900

Power supply

Accessories, consumables, spare parts and other recommended medical devices by W&H

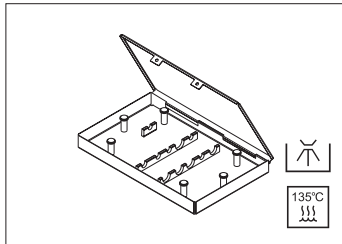

08174820

Piezomed Pro cassette

Scan the QR code to find accessories, consumables and spare parts for this medical device.



13. Technical data

Control unit M-PM100

Control unit	M-PM100
Supply voltage:	100 – 240 V
Operating voltage:	30 – 32 V DC
Frequency:	50 – 60 Hz
Maximum power output (ultrasonic):	24 W
Operating frequency:	22 – 35 kHz
Coolant flow rate at 100 %:	at least 90 ml/min
Operating mode:	S3 (60 s ON / 30 s OFF)
Dimensions in mm (height x width x depth):	90 x 140 x 285
Weight:	635 g
Length handpiece cable:	3,5 m
Foot control:	S-N2 / S-NW

Classification according to Paragraph 6 of the General Specifications for the Safety of Medical Electrical Equipment according to IEC 60601-1/ANSI/AAMI ES 60601-1

Class I medical electrical equipment (to avoid the risk of electric shock, the power supply must only be connected to a supply mains with protective earth!)

Technical data

Handpiece with cable M-PH350

Handpiece with cable	M-PH350
Maximum power consumption:	24 W
Frequency (ultrasonic)	22 – 35 kHz
Coolant flow rate at 100 %:	at least 90 ml/min
Operating mode:	S3 (60 s ON / 30 s OFF)



Type B applied part (not suitable for intracardiac application)

Temperature information



Temperature of the medical device on the operator side:	maximum 48°C (118.4°F)
Temperature of the medical device on the patient side (metal):	maximum 51°C (123.8°F)
Temperature of the medical device on the patient side (plastic):	maximum 60°C (140°F)
Temperature of the working part (instrument):	maximum 41°C (105.8°F)

Technical data

Ambient conditions

Temperature during storage and transport:	-40°C to +70°C (-40°F to +158°F)
Humidity during storage and transport:	8% to 80% (relative), non-condensing
Temperature during operation:	+10°C to +30°C (+50°F to +86°F)
Humidity during operation:	15% to 80% (relative), non-condensing

Pollution level:	2
Overvoltage category:	II
Altitude:	up to 3,000 m above sea level

14. Data on electromagnetic compatibility according to IEC/EN 60601-1-2



Operating environment and EMC warning notes

This medical device is neither life-sustaining nor coupled to the patient. It is suitable for operation both in domestic healthcare and in facilities used for medical purposes except rooms/areas, in which EMC interference of high-intensity may occur.

The customer and/or the user should assure that this medical device is set up and used in an environment of the specified type and/or in accordance with the specifications of the manufacturer. This medical device uses RF energy only for its internal functions. Therefore, its RF emissions are very low and not likely to cause any interference in nearby electronic equipment.

No special precautions are necessary to maintain the basic safety and essential performance of this medical device.



Essential performance

This medical device has no critical functions and therefore does not have any essential performance features.

Data on electromagnetic compatibility according to IEC/EN 60601-1-2



RF communication equipment

Portable RF communications equipment (including peripherals such as antenna cables and external antennas) should be used no closer than 30 cm (12 inches) to the medical device. Otherwise, degradation of the performance of this medical device could result.



W&H guarantees the compliance of the device with the EMC requirements only when used with original W&H accessories and spare parts. The use of accessories and spare parts not approved by W&H can lead to an increased emission of electromagnetic interference or to a reduced resistance against electromagnetic interference.



Use of this medical device adjacent to or stacked with other equipment should be avoided because it could result in improper operation. If such use is necessary, this medical device and the other equipment should be observed to verify that they are operating normally.



The medical device is not intended for use in the vicinity of HF surgical devices.

Results of the electromagnetic tests

Requirement	Class / Test Level*		
Electromagnetic emissions			
Mains terminal disturbance voltage (Conducted Emissions) CISPR 11/EN 55011 [150 kHz – 30 MHz]	Group 1 Class B		
Electromagnetic radiation disturbance (Radiated Emissions) CISPR 11/EN 55011 [30 MHz – 1000 MHz]	Group 1 Class B		
Harmonic distortion IEC/EN 61000-3-2	Class A		
Voltage fluctuations and flicker IEC/EN 61000-3-3	–		
Immunity to electromagnetic interference			
Electrostatic discharge (ESD) IEC/EN 61000-4-2	Contact discharge: ± 2 kV, ± 4 kV, ± 6 kV, ± 8 kV Air discharge: ± 2 kV, ± 4 kV, ± 8 kV, ± 15 kV		
Radiated RF electromagnetic fields IEC/EN 61000-4-3 [80 MHz – 2,7 GHz]	10 V/m		
Proximity fields from RF wireless communications equipment IEC/EN 61000-4-3	710 / 745 / 780 / 5240 / 5500 / 5785 MHz	9 V/m	
	385 MHz	27 V/m	
	450 / 810 / 870 / 930 / 1720 / 1845 / 1970 / 2450 MHz	28 V/m	
Electrical fast transients / bursts IEC/EN 61000-4-4	Mains supply: ± 2 kV Input and output ports: ± 1 kV		
Surges IEC/EN 61000-4-5	± 1 kV L – N	± 2 kV L – PE	± 2 kV N – PE
Conducted disturbances induced by RF fields IEC/EN 61000-4-6	3 V 6 V in ISM bands and in amateur radio bands		
Power frequency magnetic fields IEC/EN 61000-4-8	30 A/m		
Voltage dips, short interruptions and voltage variations IEC/EN 61000-4-11	0% for 0.5 cycle at 45° steps from 0°-315° 0% for 1 cycle 70% for 25/30 cycles 0% for 250/300 cycles		
Proximity magnetic fields IEC/EN 61000-4-39	30 kHz	8 A/m	
	134,2 kHz	65 A/m	
	13,56 MHz	7,5 A/m	

* There are no deviations or simplifications to IEC 60601-1-2.

15. Disposal



Ensure that the parts are not contaminated on disposal.



Follow your local and national laws, directives, standards and guidelines for disposal.

- > Medical device
- > Waste electrical equipment
- > Packaging



W&H course certificate

for the instructor

The user has been trained to use the medical device correctly in accordance with the legal regulations (medical devices marketing regulations, medical devices act). Particular attention has been paid to the chapters on safety notes, start-up, operation, hygiene and maintenance, and service (regular inspections).

Product name	Serial number (SN)
Manufacturer with address	
Distributor with address	



Name of the user	Date of birth and/or personnel number
Hospital/dental practice/department with address	
Signature of the user	
The signature confirms that the user has been trained to use the medical device and has understood the content.	



Name of the instructor	Date of instruction
Address of the instructor	
Signature of the instructor	

W&H course certificate

for the user

The user has been trained to use the medical device correctly in accordance with the legal regulations (medical devices marketing regulations, medical devices act). Particular attention has been paid to the chapters on safety notes, start-up, operation, hygiene and maintenance, and service (regular inspections).

Product name	Serial number (SN)
Manufacturer with address	
Distributor with address	

Name of the user	Date of birth and/or personnel number
Hospital/dental practice/department with address	
Signature of the user	
The signature confirms that the user has been trained to use the medical device and has understood the content.	

Name of the instructor	Date of instruction
Address of the instructor	
Signature of the instructor	

Explanation of warranty terms

This W&H medical device has been manufactured with great care by highly qualified specialists. A wide variety of tests and controls guarantees faultless operation. Please note that claims under warranty can only be validated when all the directions in the Instructions for Use have been followed.

As the manufacturer, W&H is liable for material or manufacturing defects within a warranty period of 12 months from the date of purchase. Accessories and consumables are not covered by the warranty.

We accept no responsibility for damage caused by incorrect handling or by repairs carried out by third parties not authorized to do so by W&H!

Claims under warranty accompanied by proof of purchase must be sent to the vendor or to an authorized W&H service partner. The provision of service under warranty extends neither the warranty period nor any other guarantee period.

12 months warranty

Authorized W&H service partners

Find your nearest authorized W&H service partner at <http://wh.com>
Simply go to the menu option “Service” for full details.

Or simply scan the QR code.





W&H Dentalwerk Bürmoos GmbH
Ignaz-Glaser-Straße 53, 5111 Bürmoos, Austria

t +43 6274 6236-0, **f** +43 6274 6236-55
office@wh.com **wh.com**

Form-Nr. 51076 AEN
Rev. 004 / 03.12.2025
Software version: 1.X.X
Subject to alterations