

## Instructions for use



CE  
0297

proxeo<sup>TWIST</sup>

PL-40 HW

# Contents

---

<b>1. Introduction</b> .....	7
<b>2. Scope of delivery</b> .....	9
<b>3. Safety notes</b> .....	10
<b>4. Description</b> .....	15
Handpiece drive .....	15
Foot control C-NW .....	16
Status LED handpiece drive .....	17
Status LED foot control .....	18
<b>5. Start-up</b> .....	19
Charging the battery .....	19
Query battery status .....	20
Pairing .....	21
Assembly/removal of the handpiece-/contra-angle head .....	23
<b>6. Handpiece drive</b> .....	24
Operation .....	24
<b>7. Hygiene and maintenance</b> .....	26
General notes .....	26
Limitations on processing .....	27
Initial treatment at the point of use .....	28
Manual cleaning .....	29
Manual disinfection .....	30
Automated cleaning and disinfection .....	31
Drying .....	32
Inspection, Maintenance and Testing .....	33
<b>8. Replacing the O-ring</b> .....	34

# Contents

---

<b>9. Servicing .....</b>	<b>35</b>
<b>10. Accessories, consumables, spare parts and other recommended medical devices by W&amp;H .....</b>	<b>37</b>
<b>11. Technical data .....</b>	<b>39</b>
<b>12. Data on electromagnetic compatibility according to IEC/EN 60601-1-2 .....</b>	<b>42</b>
<b>13. Disposal .....</b>	<b>45</b>
<b>Explanation of warranty terms .....</b>	<b>46</b>
<b>Authorized W&amp;H service partners .....</b>	<b>47</b>

# Symbols



**WARNING!**  
(risk of injury)



CE mark  
with identification number  
of the Notified Body



Not for re-use



**ATTENTION!**  
(to prevent damage occurring)



Medical device



Non-ionizing electromagnetic  
radiation



General explanations,  
without risk to persons or  
objects



Thermo washer disinfectable



Catalogue number



Follow instructions for use



Sterilizable  
up to the stated temperature



Serial number



Manufacturer



Non-sterilizable



DC – direct current



Date of manufacture



Class II medical  
electrical equipment



Do not dispose of with domestic  
waste

# Symbols



Not suitable for intracardiac application – Type BF appliance



Data Matrix code for product information including UDI (Unique Device Identification)



Data structure in accordance with Health Industry Bar Code



This way up



Fragile, handle with care



Keep dry



MEDICAL – GENERAL MEDICAL EQUIPMENT AS TO ELECTRICAL SHOCK, FIRE AND MECHANICAL HAZARDS ONLY IN ACCORDANCE WITH ANSI/AAMI ES60601-1:2005/(R)2012 + A1:2012 + C1:2009/(R)2012 + A2:2010/(R)2012, ANSI/AAMI ES60601-1:2005/A2:2021, CAN/CSA-C22.2 No. 60601-1:14, CAN/CSA-C22.2 No. 60601-1:14/A2:22, IEC 80601-2-60:2019. 25UX – Control No.



“Der Grüne Punkt” (The Green Dot) trademark of Duales System Deutschland GmbH



Trademark of RESY OfW GmbH for identification of recyclable transport and outer packaging of paper and cardboard



Caution! According to Federal law restricts this device to sale by or on the order of a physician, dentist, veterinarian or with the descriptive designation of any other practitioner licensed by the law of the State in which the practitioner practices to use or order the use of the device.

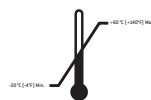

Temperature limitation



Humidity limitation

# Symbols

---



RCM – Australian / New Zealand



ANATEL – Brazil

12880-20-03402



R 209 - J00204

GITEKI (MIC) – Japan

Contains FCC ID: Q00BGM113  
Contains IC: 5123A-BGM113

FCC / IC – USA / Canada

# 1. Introduction

---

## **For your safety and the safety of your patients**

These Instructions for Use explain how to use your medical device. However, we must also warn against possible hazardous situations. Your safety, the safety of your team and, of course, the safety of your patients are of paramount importance to us.



Observe the safety notes.

## **Intended use**

**PL-40 HW:** Battery driven electrical drive unit with wireless foot controller to perform cleaning and polishing of tooth surfaces and fillings.



Misuse may damage the medical device and hence cause risks and hazards for patient, user and third parties.



## **Qualifications of the user**

We have based our development and design of the medical device on the target group “dentist, dental hygienist, dental employees (prophylaxis) and dental assistants”.

# Introduction

---

Hereby, W&H declares that the medical device is in compliance with Directive 2014/53/EU (RED).

The full text of the EU declaration of conformity is available at the following internet address <https://wh.com>

## **Responsibility of the manufacturer**

The manufacturer can only accept responsibility for the safety, reliability and performance of the medical device when it is used in compliance with the following directions:

- > The medical device must be used in accordance with these instructions for use.
- > Only the components approved by the manufacturer may be replaced (O-ring).
- > Modifications or repairs must only be undertaken by an authorized W&H service partner (see page 47).
- > The electrical installation at the premises must comply with the regulations laid out in IEC 60364-7-710 (“Installation of electrical equipment in rooms used for medical purposes”) or with the regulations applicable in your country.
- > Unauthorized opening of the medical device invalidates all claims under warranty and any other claims.

Improper use, unauthorized assembly, modification or repair to the medical device, non-compliance with our instructions or the use of accessories and spare parts which are not approved by W&H, invalidates all claims under warranty and any other claims.



Any serious incident that has occurred in relation to the medical device should be reported to the manufacturer and the competent authority!



## 2. Scope of delivery

REF	Description
30410000	Handpiece drive
07969610	Charger with adaptor
05882600	Handpiece holder

### Optional included in set

30316000	Foot control C-NW with Stick
30096000	PL-66 W Contra-angle head System LatchShort
30097000	PL-64 Contra-angle head System Screw-in Young
30098000	PL-44 Handpiece head System Doriot

### 3. Safety notes

---



- > Before using the medical device for the first time, store it at room temperature for 24 hours.
- > Check the medical device for damage and loose parts each time before using.
- > Do not operate the medical device if it is damaged.
- > Always ensure the correct operating conditions.
- > Perform a test run each time before using.
- > Never touch the patient and the electrical contacts on the medical device simultaneously.



- > Do not expose the medical device to any violent mechanical impacts.
- > The handpiece drive must not be disassembled.

#### **Battery**



- > Do not charge the battery unattended.
- > As soon as the charging cycles start to deteriorate send the medical device to an authorized W&H service partner.
- > Defective or worn-out batteries must only be replaced by an authorized W&H service partner.



- > Charge the battery of the medical device as soon as the status LED flashes.
- > Incorrect use of the rechargeable battery can cause fire or corrosion.

## Safety notes

---

 The medical device is classed as “conventional equipment” (closed equipment without protection against the ingress of water).

 The medical device is not approved for operation in potentially explosive atmospheres.

 **Charger**  
> Only use chargers approved by W&H.

 **Hygiene and maintenance prior to initial use**  
> Clean and disinfect the medical device.

 **System failure**  
A total system failure does not constitute a critical fault.  
Simply switch the unit off and then on again.

## Safety notes

---



### **Risks due to electromagnetic fields**

This medical device is suitable for use on patients with cardiac pacemakers, if a safety distance between the medical device and the cardiac pacemaker of at least 15 cm (5,9 inch) is maintained. The functionality of other active implantable medical devices (AIMD) (e.g. ICD) can be affected by electric, magnetic and electromagnetic fields.

- > Find out if the patient has other active implantable medical devices (AIMD) before using the medical device and inform about the risks.
- > Do not place the applied part on the patient's body.

## Safety notes

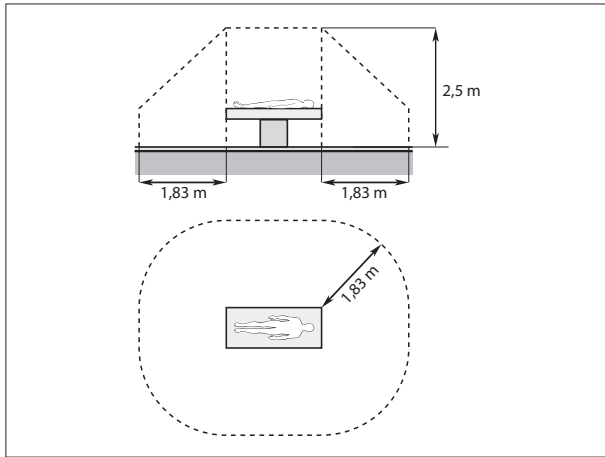

The patient environment (see diagram) encompasses the area up to 2.50 m above the patient and 1.83 m in all horizontal directions.



The charger must not be used within the patient environment.



- > Use only the handpiece drive with the handpiece-/contra-angle head PL-44, PL-66 W, PL-64.
- > Follow the directions and safety notes in the Instructions for Use of the handpiece-/contra-angle head.

## 4. Description

## Handpiece drive

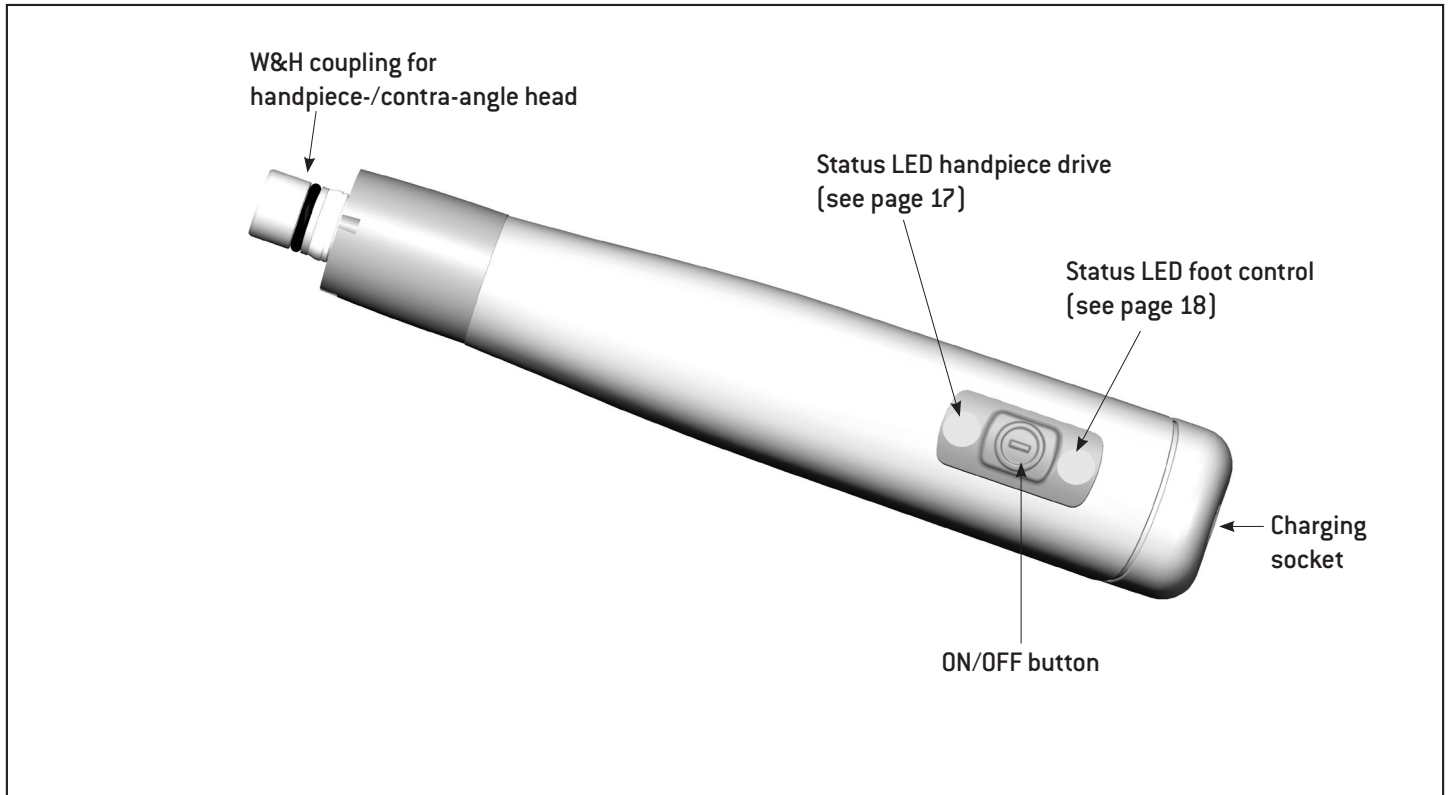

# Description

# Foot control C-NW

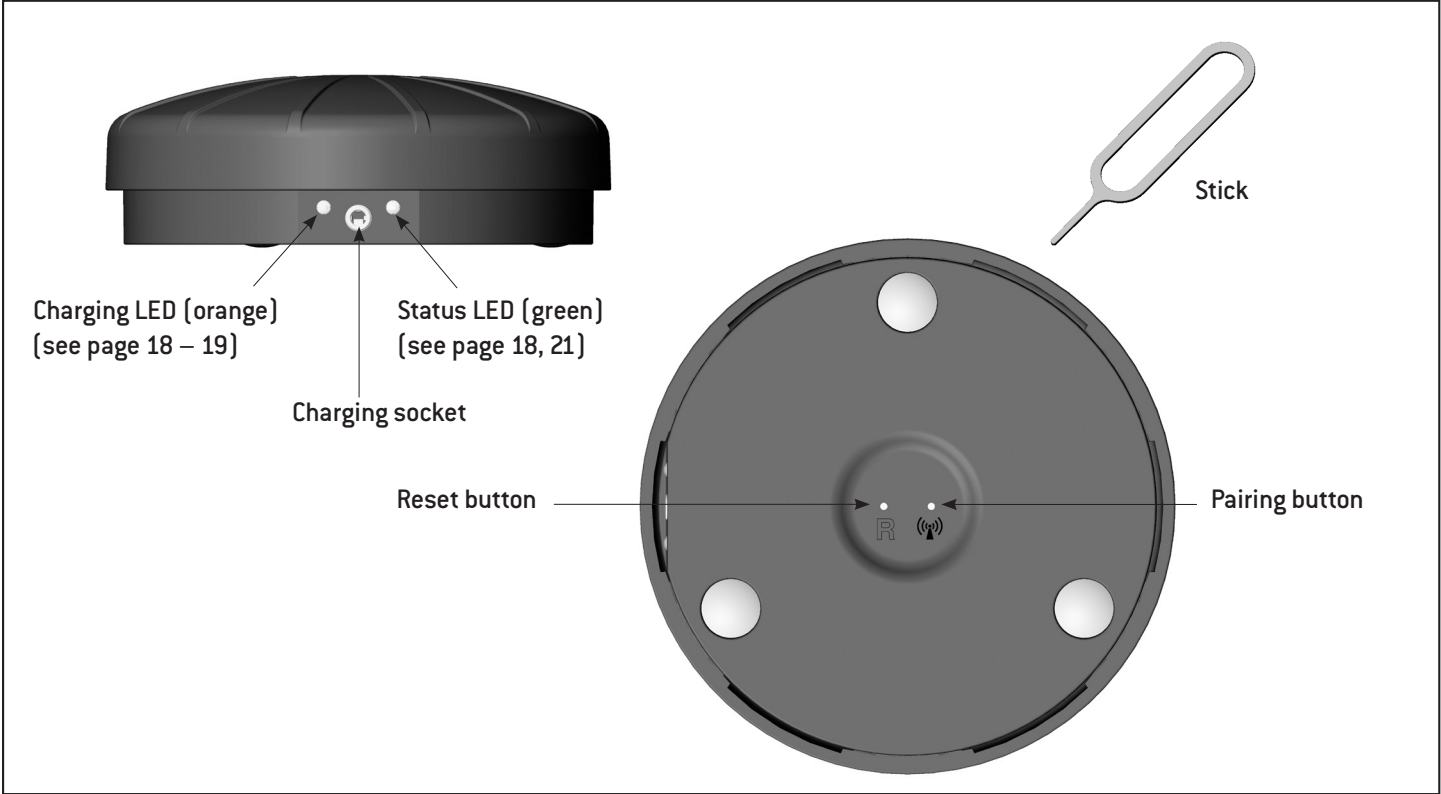



## Description

## Status LED handpiece drive



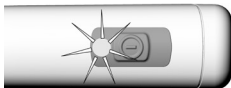

### Standby mode

- > The handpiece can be activated with the ON/OFF button.
- > If the handpiece drive is not used for longer than 4 minutes, it returns to standby mode automatically.

LED	steady	flashes	flashes intermittently
			
<b>GREEN</b>	<ul style="list-style-type: none"> <li>→ Battery is 25–100 % charged</li> <li>→ Pairing successful</li> <li>&gt; Handpiece drive is ready for operation (charging cable must be disconnected)</li> </ul>	<ul style="list-style-type: none"> <li>→ Pairing active</li> </ul>	
<b>ORANGE</b>	<ul style="list-style-type: none"> <li>→ Battery is charging</li> <li>&gt; Not ready for operation</li> </ul>	<ul style="list-style-type: none"> <li>→ Battery is 2–25 % charged</li> <li>&gt; Complete the treatment</li> <li>&gt; Do not start any further treatment</li> <li>&gt; Charge the battery</li> </ul>	<ul style="list-style-type: none"> <li>→ Battery is 1 % charged</li> <li>&gt; Charge the battery</li> </ul>
<b>RED</b>		<ul style="list-style-type: none"> <li>→ Error message</li> <li>&gt; Contact an authorised W&amp;H service partner</li> </ul>	

# Description





## Status LED foot control

LED	flashes	flashes alternately
		
<b>ORANGE</b>	<ul style="list-style-type: none"> <li>→ Battery of foot control is flat</li> <li>&gt; Complete the treatment</li> <li>&gt; Charge the battery of the foot control</li> </ul>	<ul style="list-style-type: none"> <li>→ Pairing unsuccessful</li> <li>&gt; Troubleshooting with pairing problems (see page 22)</li> </ul>



### Standby mode

> The foot control can be activated by pressing.

LED	steady	steady	flashes	flashes intermittently*
				
<b>GREEN</b>	<ul style="list-style-type: none"> <li>→ Connection to paired medical device established</li> </ul>		<ul style="list-style-type: none"> <li>→ Foot control is attempting to establish a connection to the paired medical device</li> </ul>	<ul style="list-style-type: none"> <li>→ Battery is flat</li> <li>&gt; Charge the battery</li> </ul>
<b>ORANGE</b>		<ul style="list-style-type: none"> <li>→ Battery is charging</li> </ul>		

\* The LED flashes for 40 milliseconds every 4 seconds

## 5. Start-up

## Charging the battery

 Charge the medical device fully before you use them for the first time.

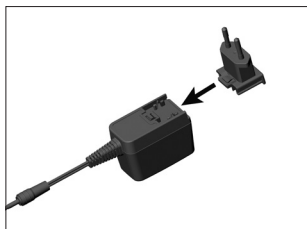

- 1** Attach the adaptor to the power supply unit.

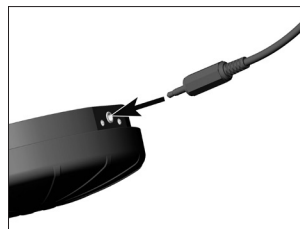

- 2** Plug the charger into an power socket.

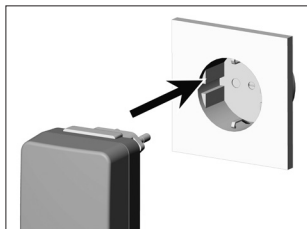

- 3** Insert the charging cable into the handpiece drive charging socket until it audibly engages.

 LED orange: Battery is charging.  
LED green: Battery is charged.

 The handpiece drive does not switch to standby mode and it is not ready for operation until it is connected to the charging cable.

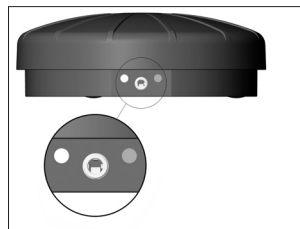

- 4** Connect the charging cable into the foot control charging socket.

 LED orange: Battery is charging.

 LED off: Battery is charged.



You can query the battery status when the handpiece drive is switched on and during the charging process.

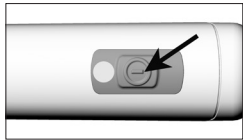

> Briefly press the ON/OFF button:

LED	flashes	Battery status
		
	3 x green	75–100 %
	2 x green	50–75 %
	1 x green	25–50 %
	orange	2–25 %

 The foot control and handpiece drive are already paired when delivered!  
If pairing is active: Status LED (green) flashes on the foot control.

- > Both devices need to be in pairing mode for it to be possible to pair the handpiece drive and foot control.
- > To activate the handpiece drive's pairing mode, place it in the vicinity of the foot control.

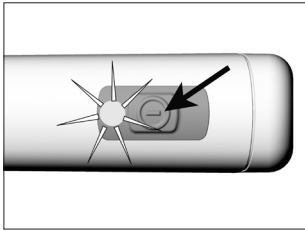

**1** Press the ON/OFF button on the handpiece drive for 5 seconds.

 LED flashing green: The handpiece drive is in pairing mode for 30 seconds.

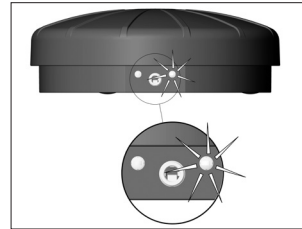

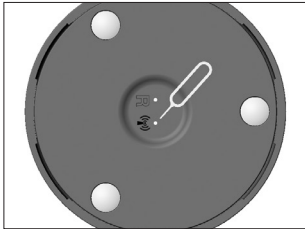

 After 3 seconds the status LED switches from flickering to flashing. The foot control's pairing mode is now activated.

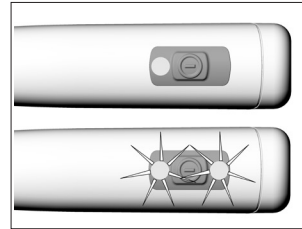

**2** Use the stick to press the pairing button on the foot control for 3 seconds.



 Pairing successful. LED green.

 Pairing unsuccessful. LED flashing alternately orange. The LED goes out after 10 seconds.

## Troubleshooting with pairing problems

- > Remove any metallic objects located between the foot control and handpiece drive.
- > Change the position of the foot control.
- > Eliminate any sources of interference (e.g. brush motors, mobile telephones, radios, WLAN, ...)
- > Use the stick to press the reset button on the foot control and try pairing again.

If the pairing problem cannot be remedied using the steps described above, the unit will need to be inspected by an authorized W&H service partner.

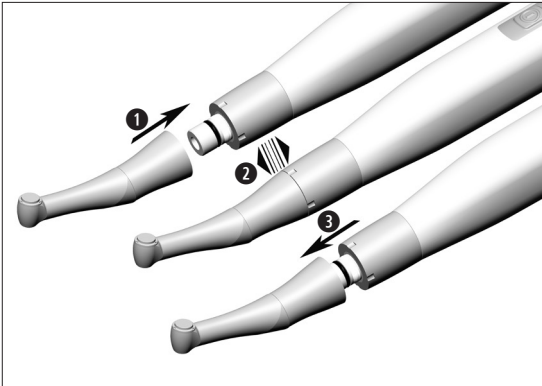

Do not assemble or remove the handpiece-/contra-angle head during operation!

① Push the handpiece-/contra-angle head onto the handpiece drive.



② Verify full engagement.

or

③ Remove the handpiece-/contra-angle head.

## 6. Handpiece drive

## Operation

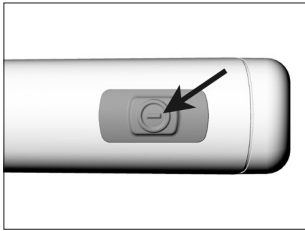

### Switch on

- 1 Press the ON/OFF button.

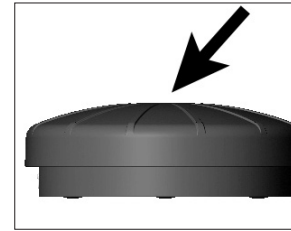

- 2 Press the foot control to variably control the speed of the rotary instrument.

 Press the foot control as far as it will go to attain the maximum speed of 3,000 rpm.

The following light signals are shown on the foot control:

Foot control pressed	
Status LED (green) flashes	Foot control is attempting to establish a connection to the paired medical device
Status LED (green) steady	Connection to paired medical device established

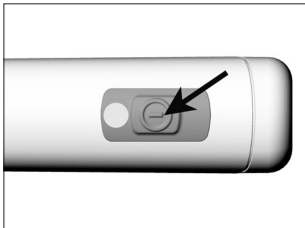

### Switch off

- 1 Keep the ON/OFF button depressed for 2 seconds.



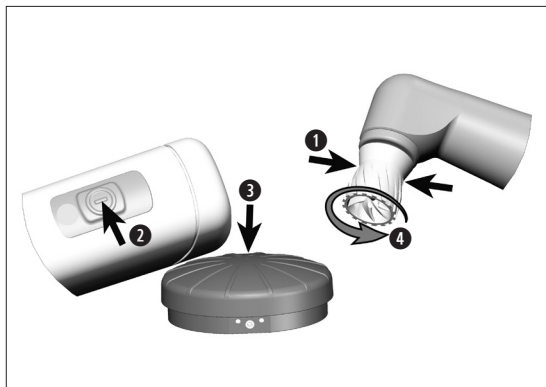

## Reverse operation



For unscrewing the Screw-in Prophy Cups or Brushes.

- 1 Hold the Cup or Brush firmly.
- 2 Keep pressed the ON/OFF button of the handpiece drive.
- 3 And press the foot control.
- 4 The Cup or Brush is unscrewed.

## Test run



Do not hold the handpiece drive at eye level!

- > Attach the handpiece-/contra-angle head to the handpiece drive.
- > Insert the rotary instrument.
- > Operate the handpiece drive with the foot control.



In the event of operating malfunctions (e.g., vibrations, unusual noise or overheating) **stop the medical device immediately** and contact an authorized W&H service partner.



Follow your local and national laws, directives, standards and guidelines for cleaning and disinfection.



> Wear protective clothing, safety glasses, face mask and gloves.



### **Cleaning agents and disinfectants**

- > Read the notes, follow the instructions and heed the warnings provided by the manufacturers of cleaning agents and/or disinfectants.
- > Use only detergents which are intended for cleaning and/or disinfecting medical devices made of metal and plastic.
- > It is imperative to comply with the concentrations and exposure times specified by the manufacturer of the disinfectant.
- > Use disinfectants which have been tested and found effective by the **Verbund für Angewandte Hygiene e.V.** (VAH = Association for Applied Hygiene), the **Österreichischen Gesellschaft für Hygiene, Mikrobiologie und Präventivmedizin** (ÖGHMP = Austrian Society for Hygiene, Microbiology and Preventive Medicine), the **Food and Drug Administration (FDA)** and the **U.S. Environmental Protection Agency (EPA)**.
- > The user is responsible for validating its process if the specified cleaning agents and disinfectants are not available.



The product lifetime and the medical device's ability to operate correctly are mainly determined by mechanical stress during use and chemical influences due to processing.

- > Send worn or damaged medical devices and/or medical devices with material changes to an authorized W&H service partner.



- > Clean the medical device immediately after every treatment.
- > Wipe the entire handpiece drive and the handpiece holder with disinfectant.



- > Ensure that no fluids enter the medical device.



- > Switch the handpiece drive off.
- > The charger must not be connected.



- > Note that the disinfectant used during pre-treatment is only for personal protection and cannot replace the disinfection step after cleaning.



- > Do not place the handpiece drive and the handpiece holder in liquid disinfectant or in an ultrasonic bath.
- > Do not immerse the handpiece drive in water or clean them under running water.



Evidence of the handpiece drive's basic suitability for effective manual cleaning was provided by an independent test laboratory using tap water < 35°C and towels/cloth »WIPEX® WET DESI premium« (NORDVLIES GmbH, Bargteheide).

## Handpiece holder

- > Clean the handpiece holder under running tap water (< 35°C / < 95°F).
- > Rinse and brush off all internal and external surfaces.
- > Remove liquid residues using compressed air.



> W&H recommends wiping down with disinfectant.



Evidence of the basic suitability of the handpiece drive and the handpiece holder for effective manual disinfection was provided by an independent test laboratory using the “mikrozid® AF wipes” disinfectant (Schülke & Mayr GmbH, Norderstedt) and “CaviWipes™” (Metrex).



- > The handpiece drive and the handpiece holder are not approved for automated processing in a washer-disinfector and sterilization.



- > Ensure that the medical device is completely dry internally and externally after cleaning and disinfection.
- > Remove liquid residues using compressed air.





- > Check the medical device after cleaning and disinfection for damage, visible residual soiling and surface changes.
- > Reprocess any medical devices that are still soiled.

## 8. Replacing the O-ring



Do not use sharp tools!

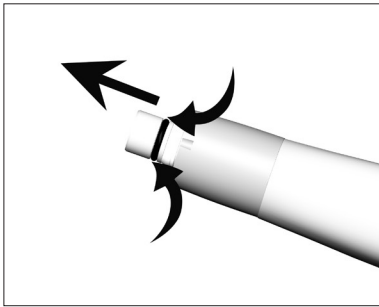

- ① Squeeze the O-ring between your thumb and index finger firmly so that it forms a loop.
- ② Pull the old O-ring off.
- ③ Push the new O-ring on in its place.

## 9. Servicing

---



### **Periodic inspection**

Regular periodic inspection of the function and safety of the medical device is necessary and should be carried out at least once every three years, unless shorter intervals are prescribed by law. The periodic inspection covers the complete medical device and must only be performed by an authorized service Partner.

# Servicing

---

## Repairs and returns

In the event of operating malfunctions immediately contact an authorized W&H service partner.  
Repairs and maintenance work must only be undertaken by an authorized W&H service partner.



> Ensure that the medical device has been completely processed before returning it.



> Always return equipment in the original packaging!

## 10. Accessories, consumables, spare parts and other recommended medical devices by W&H



Use only original W&H accessories and spare parts or accessories approved by W&H.

Supplier: W&H partners



**07947190**

Handpiece drive

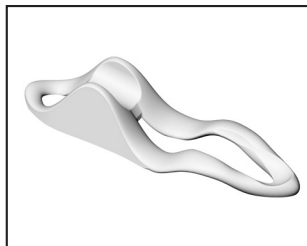

**05882600**

Handpiece holder

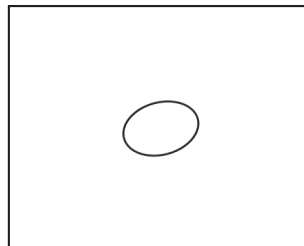

**01225100**

O-ring

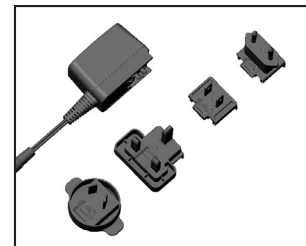

**07969610**

Charger incl. adaptor



**30316000**

Foot control C-NW  
with Stick

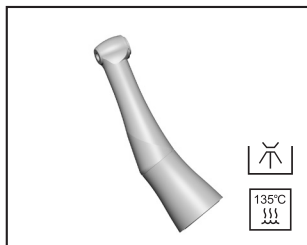

**30096000**

PL-66 W Contra-angle head  
System LatchShort



135°C  
111

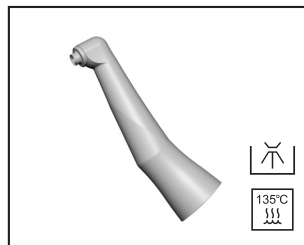

**30097000**

PL-64 Contra-angle head  
System Screw-in Young



135°C  
111

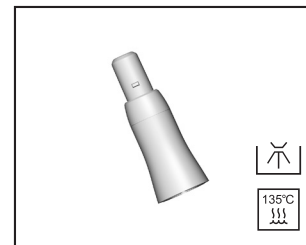

**30098000**

PL-44 Handpiece head  
System Doriot



135°C  
111

## Accessories, consumables, spare parts and other recommended medical devices by W&H

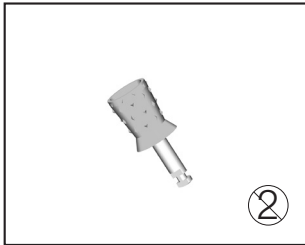

**07597900**

Prophy Cups, firm, LatchShort

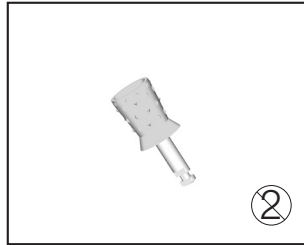

**08003630**

Prophy Cups, soft, LatchShort

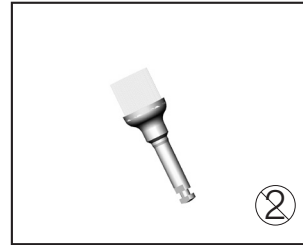

**08003650**

Prophy Brushes, cup-shaped,  
soft, LatchShort

Scan the QR code to find accessories,  
consumables and spare parts for this  
medical device.



## 11. Technical data

### Ambient conditions

Temperature during storage and transport:	-20°C to +60°C [-4°F to +140°F]
Humidity during storage and transport:	8% to 80% [relative], non-condensing
Temperature during operation:	+10°C to +35°C [+50°F to +95°F]
Humidity during operation:	15% to 80% [relative], non-condensing

Handpiece drive	PL-40 HW
Battery type:	Li-Ion
Runtime:	8 treatments with a polishing duration of 6 min.
Standby:	automatically after 4 min.
Charging time:	approx. 2 h
Rated voltage:	3.7 V
Rated capacity:	680 mAh
Max. speed:	12,000 rpm
Max. speed with rotary instrument:	3,000 rpm
Max. torque with rotary instrument:	2 Ncm
Dimensions (WxDxH):	141 x 25 x 28 mm
Weight:	105 g

## Technical data

Frequency band:	2.4 GHz ISM band (2,402 – 2,480 GHz)
Transmitting power:	3 dBm
Modulation:	GFSK
Channels:	40 channels with 2 MHz spacing

<b>Charger</b>	
Rated voltage:	100 - 240 V
Permissible voltage fluctuation:	$\pm 10 \%$
Frequency:	50 – 60 Hz
Power:	7 VA



## Technical data

---

Classification according to Paragraph 6 of the General Specifications for the Safety of Medical Electrical Equipment according to IEC 60601-1/ANSI/AAMI ES 60601-1



Charger: Class II medical electrical equipment (protective earth conductor used for functional earth connection only!)

Handpiece drive: Internally powered



Type BF applied part (not suitable for intracardiac application)

Pollution level: 2  
Overvoltage category: II  
Altitude: up to 3,000 m above sea level



### Temperature information

Temperature of the handpiece at the operator side: maximum 56°C (max. 133°F)  
Temperature of the handpiece at the patient side (metal): maximum 51°C (max. 123.8°F)

## 12. Data on electromagnetic compatibility according to IEC/EN 60601-1-2

---



### **Operating environment and EMC warning notes**

This medical device is neither life-sustaining nor coupled to the patient. It is suitable for operation both in domestic healthcare and in facilities used for medical purposes except rooms/areas, in which EMC interference of high-intensity may occur. The customer and/or the user should assure that this medical device is set up and used in an environment of the specified type and/or in accordance with the specifications of the manufacturer. This medical device uses RF energy only for its internal functions. Therefore, its RF emissions are very low and not likely to cause any interference in nearby electronic equipment.

No special precautions are necessary to maintain the basic safety and essential performance of this medical device



### **Essential performance**

This medical device has no critical functions and therefore does not have any essential performance features.

## Data on electromagnetic compatibility according to IEC/EN 60601-1-2

---



### **RF communication equipment**

Portable RF communications equipment (including peripherals such as antenna cables and external antennas) should be used no closer than 30 cm (12 inches) to the medical device. Otherwise, degradation of the performance of this medical device could result.



W&H guarantees the compliance of the device with the EMC requirements only when used with original W&H accessories and spare parts. The use of accessories and spare parts not approved by W&H can lead to an increased emission of electromagnetic interference or to a reduced resistance against electromagnetic interference.



Use of this medical device adjacent to or stacked with other equipment should be avoided because it could result in improper operation. If such use is necessary, this medical device and the other equipment should be observed to verify that they are operating normally.



The medical device is not intended for use in the vicinity of HF surgical devices.

# Results of the electromagnetic tests

Requirement	Class / Test Level*		
<b>Electromagnetic emissions</b>			
Mains terminal disturbance voltage (Conducted Emissions) CISPR 11/EN 55011 [150 kHz – 30 MHz]	Group 1 Class B		
Electromagnetic radiation disturbance (Radiated Emissions) CISPR 11/EN 55011 [30 MHz – 1000 MHz]	Group 1 Class B		
Harmonic distortion IEC/EN 61000-3-2	Class A		
Voltage fluctuations and flicker IEC/EN 61000-3-3	–		
<b>Immunity to electromagnetic interference</b>			
Electrostatic discharge (ESD) IEC/EN 61000-4-2	Contact discharge: $\pm 2$ kV, $\pm 4$ kV, $\pm 6$ kV, $\pm 8$ kV Air discharge: $\pm 2$ kV, $\pm 4$ kV, $\pm 8$ kV, $\pm 15$ kV		
Radiated RF electromagnetic fields IEC/EN 61000-4-3 [80 MHz – 2.7 GHz]	10 V/m		
Proximity fields from RF wireless communications equipment IEC/EN 61000-4-3	710 / 745 / 780 / 5240 / 5500 / 5785 MHz	9 V/m	
	385 MHz	27 V/m	
	450 / 810 / 870 / 930 / 1720 / 1845 / 1970 / 2450 MHz	28 V/m	
Electrical fast transients / bursts IEC/EN 61000-4-4	Mains supply: $\pm 2$ kV		
Surges IEC/EN 61000-4-5	$\pm 1$ kV L – N	$\pm 2$ kV L – PE	$\pm 2$ kV N – PE
Conducted disturbances induced by RF fields IEC/EN 61000-4-6	3 V 6 V in ISM bands and in amateur radio bands		
Power frequency magnetic fields IEC/EN 61000-4-8	30 A/m		
Voltage dips, short interruptions and voltage variations IEC/EN 61000-4-11	0% for 0.5 cycle at 45° steps from 0°-315° 0% for 1 cycle 70% for 25/30 cycles 0% for 250/300 cycles		
Proximity magnetic fields IEC/EN 61000-4-39	30 kHz	8 A/m	
	134.2 kHz	65 A/m	
	13.56 MHz	7.5 A/m	

\* There are no deviations or simplifications to IEC/EN 60601-1-2.

## 13. Disposal

---



Ensure that the parts are not contaminated on disposal.



Follow your local and national laws, directives, standards and guidelines for disposal.

- > Medical device
- > Waste electrical equipment
- > Packaging

# Explanation of warranty terms

This W&H medical device has been manufactured with great care by highly qualified specialists. A wide variety of tests and controls guarantees faultless operation. Please note that claims under warranty can only be validated when all the directions in the Instructions for Use have been followed.

**As the manufacturer, W&H is liable for material or manufacturing defects within a warranty period of 12 months from the date of purchase. Accessories and consumables are excluded from the warranty.**

We accept no responsibility for damage caused by incorrect handling or by repairs carried out by third parties not authorized to do so by W&H!

Claims under warranty accompanied by proof of purchase must be sent to the vendor or to an authorized W&H service partner. The provision of service under warranty extends neither the warranty period nor any other guarantee period.

**12** months warranty

## Authorized W&H service partners

---

Find your nearest authorized W&H service partner at <http://wh.com>  
Simply go to the menu option “Service” for full details.

Or simply scan the QR code.





**W&H Dentalwerk Bürmoos GmbH**  
Ignaz-Glaser-Straße 53, 5111 Bürmoos, Austria

**t** +43 6274 6236-0,    **f** +43 6274 6236-55  
**office@wh.com**        **wh.com**

Form-Nr. 51037 AEN  
Rev. 005 / 14.11.2024  
Software version 1.X.X  
Subject to alterations