

# Instructions for Use

Edition USA



CE  
0297

implantmed<sup>PLUS</sup>

SI-1010 / SI-1015 / SI-1023

# Contents

---

<b>Symbols</b> .....	4
<b>1. Introduction</b> .....	8
<b>2. Unpacking</b> .....	10
<b>3. Scope of delivery</b> .....	11
<b>4. Safety notes</b> .....	12
<b>5. Description</b> .....	17
of front panel .....	17
of rear panel .....	18
of foot control S-N2/S-NW .....	19
<b>6. Start-up</b> .....	21
<b>7. Starting operation</b> .....	23
<b>8. Control unit operation</b> .....	24
Main menu .....	24
Menue Navigation .....	27
Documentation with USB stick .....	33
ioDent® platform .....	35
Beacon .....	37
<b>9. Error messages</b> .....	38

# Contents

---

<b>10. Hygiene and maintenance</b> .....	41
General notes .....	41
Limitations on processing.....	42
Initial treatment at the point of use .....	43
Manual cleaning .....	44
Manual disinfection .....	45
Automated cleaning and disinfection .....	46
Drying.....	47
Inspection, maintenance and testing .....	48
Packaging.....	49
Sterilization .....	50
Storage .....	52
<b>11. Servicing</b> .....	53
<b>12. Accessories, consumables, spare parts and other recommended medical devices by W&amp;H</b> .....	55
<b>13. Technical data</b> .....	58
<b>14. Data on electromagnetic compatibility according to IEC/EN 60601-1-2</b> .....	60
<b>15. Disposal</b> .....	63
<b>W&amp;H course certificate</b> .....	64
<b>Explanation of warranty terms</b> .....	67
<b>Authorized W&amp;H service partners</b> .....	68

# Symbols



**WARNING!**  
(if persons could be injured)



Sterilizable up to the stated  
temperature



Do not dispose of with  
domestic waste



**ATTENTION!**  
(if property could be damaged)



CE marking with identification  
number of the Notified Body



DataMatrix code for product  
information including UDI  
(Unique Device Identification)



General explanations, without  
risk to persons or property



Manufacturer



Serial number



Medical Device



Date of manufacture



Catalogue number



Thermo washer disinfectable

# Symbols



Follow Instructions for Use

**VA**

Power consumption  
(volt-ampere)

**A**

Electric current (ampere)



Class II equipment



Electric fuse

**Hz**

Frequency (hertz)



Foot control



Earth



MEDICAL – GENERAL MEDICAL EQUIPMENT AS TO ELECTRICAL SHOCK, FIRE AND MECHANICAL HAZARDS ONLY IN ACCORDANCE WITH ANSI/AAMI ES60601-1:2005/[R]2012 + A1:2012 + C1:2009/[R]2012 + A2:2010/[R]2012, ANSI/AAMI ES60601-1:2005/A2:2021, CAN/CSA-C22.2 No. 60601-1:14, CAN/CSA-C22.2 No. 60601-1:14/A2:22, IEC 80601-2-60:2019. 25UX – Control No.



Off

**V**

Electric voltage (volt)



On

**AC**

Alternating current

# Symbols

**rpm** Revolutions per minute  
(= rpm)

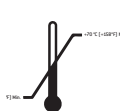

Temperature limitation



This way up



Humidity limitation



Fragile, handle with care



Data structure in  
accordance with Health  
Industry Bar Code



Keep dry



Trademark of RESY OfW GmbH  
for identification of recyclable  
transport and outer  
packaging of paper and  
cardboard



“Der Grüne Punkt” (The Green  
Dot) trademark of Duales  
System Deutschland GmbH

**R<sub>x</sub>**<sub>only</sub>

Caution! According to  
Federal law restricts this  
device to sale by or on the  
order of a physician, dentist,  
veterinarian or with the  
descriptive designation of any  
other practitioner licensed by  
the law of the State in which  
the practitioner practices to  
use or order the use of the  
device.

# Symbols



Batch code



Use by



Latex-free



Not for re-use



Do not use when package is damaged



Sterilization with ethylene oxide



Do not re-sterilize



Keep away from heat



Single sterile barrier system

# 1. Introduction

---



## **For your safety and the safety of your patients**

These Instructions for use explain how to use your medical device. However, we must also warn against possible hazardous situations. Your safety, the safety of your team and, of course, the safety of your patients, are of paramount importance to us.



Observe the safety notes.

## **Indication for use**

Mechanical drive unit with coolant supply for transmission instruments with ISO 3964 (DIN 13940) compatible coupling system, for use in dental surgery, implantology and maxillofacial surgery (CMF) for treatment of dental hard tissue.



Misuse may damage the medical device and hence cause risks and hazards for patients, users and third parties.



## **Qualifications of the user**

Only suitably qualified medical, technical and specialist trained staff may use the medical device.

We have based our developed and design of the medical device on the »physician« target group.



# Introduction

---

## Responsibility of the manufacturer

The manufacturer can only accept responsibility for the safety, reliability and performance of the medical device when compliance with the following instructions is ensured:

- > The medical device must be used in accordance with these Instructions for Use.
- > The medical device has no components that can be repaired by the user.
- > Modifications or repairs must only be undertaken by an authorized W&H service partner (see page 68).
- > The electrical installation at the premises must comply with the regulations laid out in IEC 60364-7-710 (“Installation of electrical equipment in rooms used for medical purposes”) or with the regulations applicable in your country.
- > Unauthorized opening of the control unit invalidates all claims under warranty and any other claims.

Improper use, unauthorized assembly, modification or repair to the medical device, non-compliance with our instructions or the use of accessories and spare parts which are not approved by W&H, invalidates all claims under warranty and any other claims.



Any serious incident that has occurred in relation to the medical device should be reported to the manufacturer and the competent authority!

## 2. Unpacking

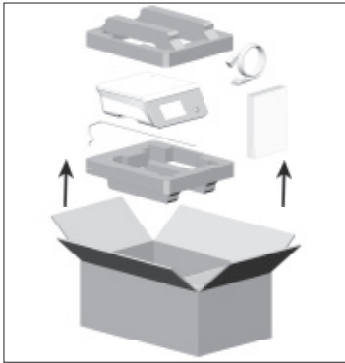

Lift out the insert with the medical device. Remove the mains cable, irrigant support, universal support and Instructions for Use.

W&H packaging is environmentally friendly and can be disposed of by industrial recycling companies. However, we recommend that you keep the original packaging.

### 3. Scope of delivery

Control unit		SI-1023 (230V) 30288000	SI-1015 (120V) 30289000	SI-1010 (100V) 30290000
REF 07721800	Universal support		X	
REF 04005900	Irrigant support		X	
Mains cable country-specific			X	

#### Optional included in set

REF 04363600	Irrigation tubing set 2.2 m (6 pcs, disposable)
REF 3028100x	EM-19 LC motor with electrical contacts and 1.8 m or 3.5 m cable
REF 30185000	EM-19 motor without electrical contacts with 1.8 m cable
REF 30264000	Foot control S-NW
REF 30285000	Foot control S-N2
REF 07759700	SPI dongle

## 4. Safety notes

---



- > Before using the medical device for the first time, store it at room temperature for 24 hours
- > Check the medical device for damage and loose parts each time before using.
- > Do not operate the medical device if it is damaged.
- > Check the parameter settings every time the device is restarted.
- > Perform a test run prior to every treatment.
- > The responsibility for the use and timely shutdown of the system lies with the user.
- > Ensure that it is possible to complete the operation safely should the units or instruments fail.



The medical device is not approved for operation in potentially explosive atmospheres.  
The medical device is not approved for operation in oxygen rich Environment.

## Safety notes

---



- > Use only original W&H fuses.
- > Never touch the patient and the electrical contacts on the control unit simultaneously.
- > Make sure that no computer viruses are transferred to the control unit by an external data medium (USB stick).



The connection of a USB hard drive with an external power source is not permitted.



The control unit is classed as “conventional equipment” (closed equipment without protection against the ingress of water).



Use the WS-75, WI-75 and SZ-75 (20:1) ratios exclusively with the contra-angle handpieces approved by W&H. Use of other contra-angle handpieces may result in deviation from the indicated torque. The user alone is therefore responsible for the above. The manufacturer does not accept any liability.



### **Power failure**

In the event of a power failure, if the control unit is switched off, or when switching between programs, the last values set are saved and re-activated on power-up.

### **System failure**

A total system failure does not constitute a critical fault.

## Safety notes

---



### **Mains cable / Power switch**

- > Only use the mains cable supplied.
- > Plug the mains cable only into an earthed power socket.
- > Set up the control unit so the power switch and the socket are easily accessible at all times.



### **Disconnect the control unit from the power supply in case of danger.**

- > Turn off the control unit at the power switch.
- > Pull the power plug out of the socket.



Observe the manufacturer's speed and torque specifications for retaining screws for superstructures. Adjusting these retaining screws with an electric motor presents a potential risk as described above.

Note that when using or setting low speeds, the operation or run-down of rotary instruments is more difficult to detect.



Observe the manufacturer's speed and torque specifications for instruments, implants and osseodensification burs.

## Safety notes

---



### **Risks due to electromagnetic fields**

The functionality of active implantable medical devices (AIMD) (e.g. cardiac pacemaker, ICD) can be affected by electric, magnetic and electromagnetic fields.

- > Find out if the patient has active implantable medical devices (AIMD) before using the medical device and inform about the risks.



Follow the directions and safety notes in the Instructions for Use of the foot control, the electric motors and the transmission handpieces.

## Safety notes

---

### Coolant supply



The medical device is designed for use with physiological saline solution.



- > Always ensure correct operating conditions and that sufficient and adequate coolant is delivered.
- > Always provide sufficient coolant and ensure the appropriate suction.
- > Use only suitable coolants and follow the manufacturer's medical data and instructions.
- > Only use an irrigation tubing set approved by W&H or accessories approved by W&H.

### Irrigation tubing set



- > Note the expiration date and only use disposable irrigation tubing with undamaged packaging.
- > Replace the disposable irrigation tubing immediately after every treatment.
- > Follow your local and country-specific laws, directives, standards and guidelines for disposal.

### Hygiene and maintenance prior to initial use



- > Clean and disinfect the control unit, the universal support and the irrigant support.
- > Sterilize the universal support.



## 5. Description

of front panel

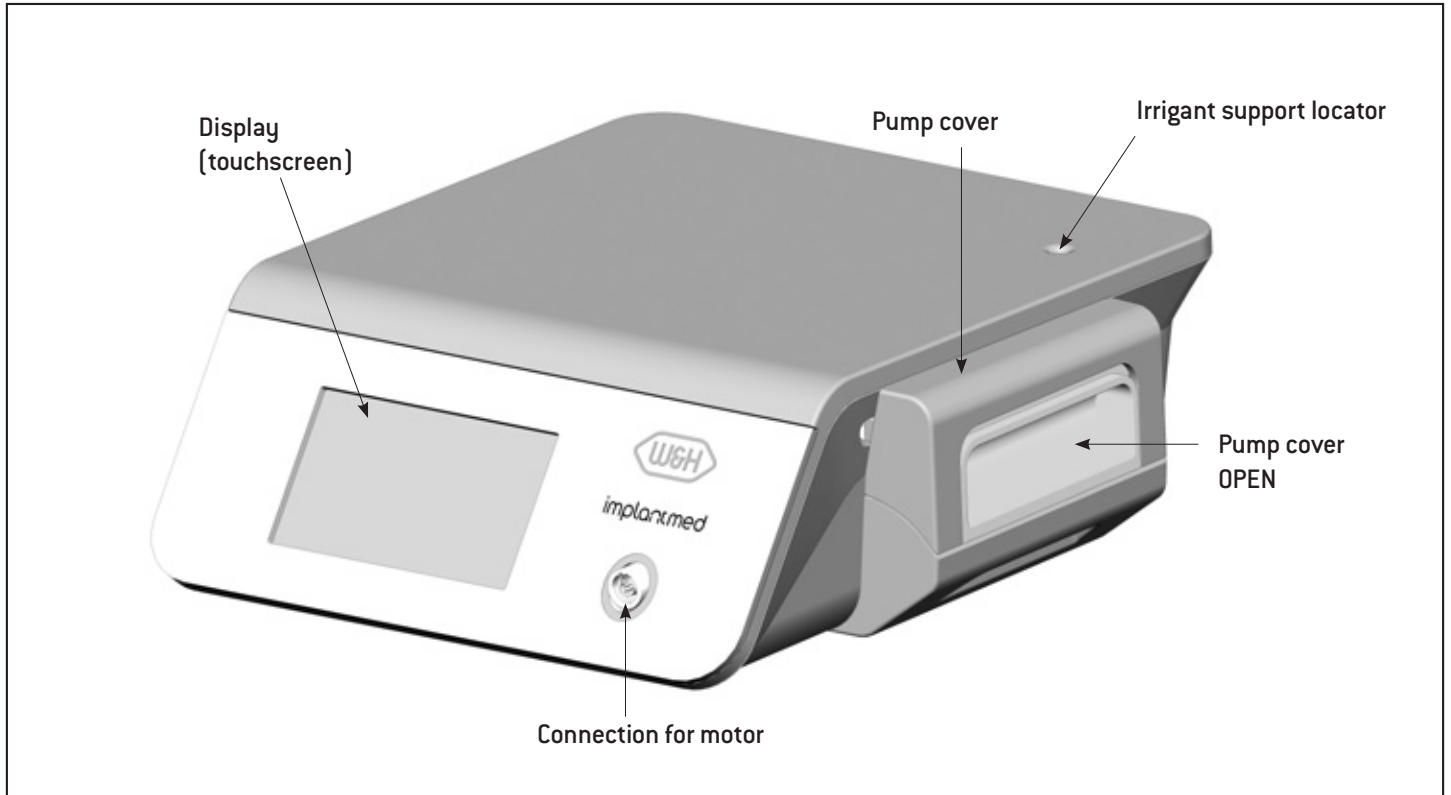

# Description

# of rear panel

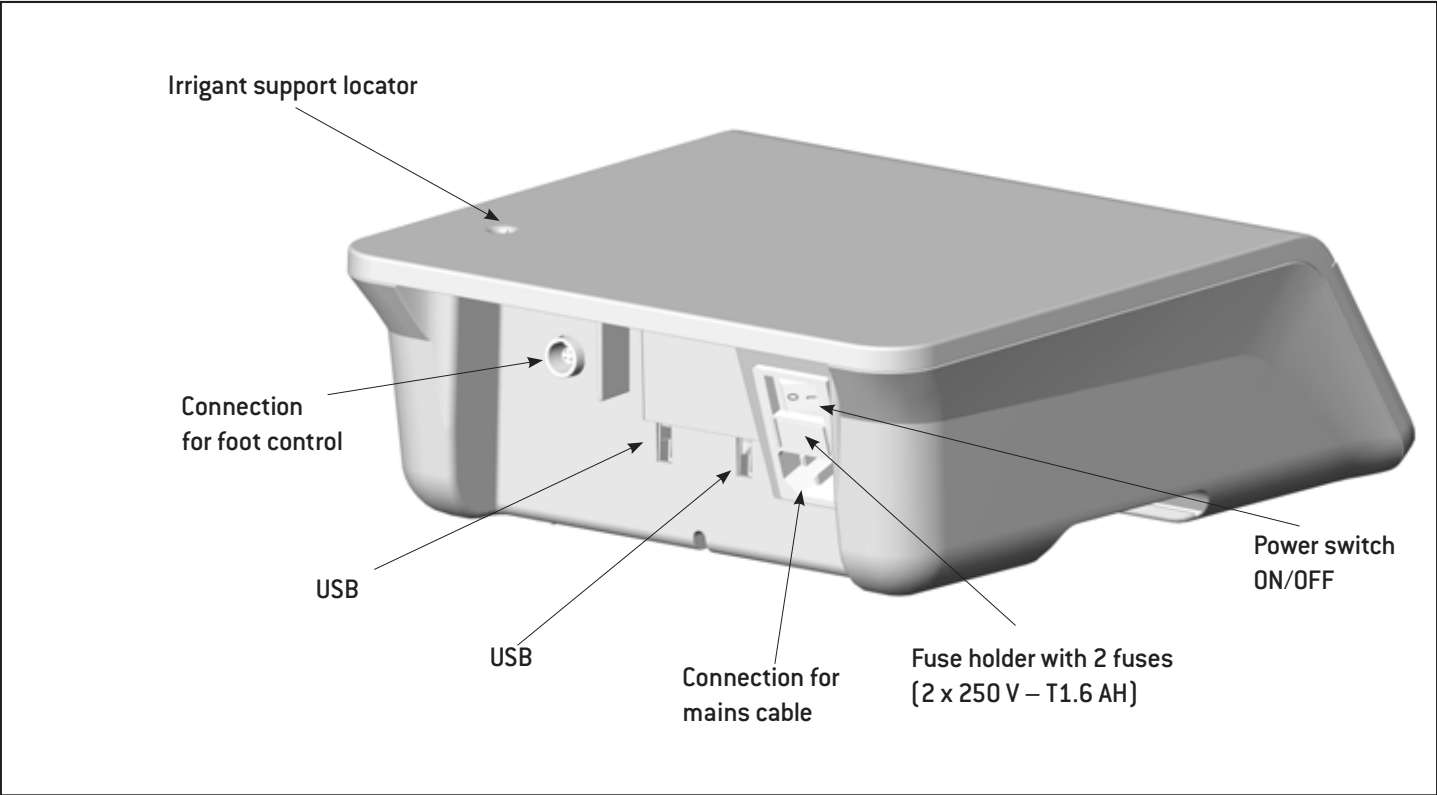

# Description

# of foot control S-N2/S-NW

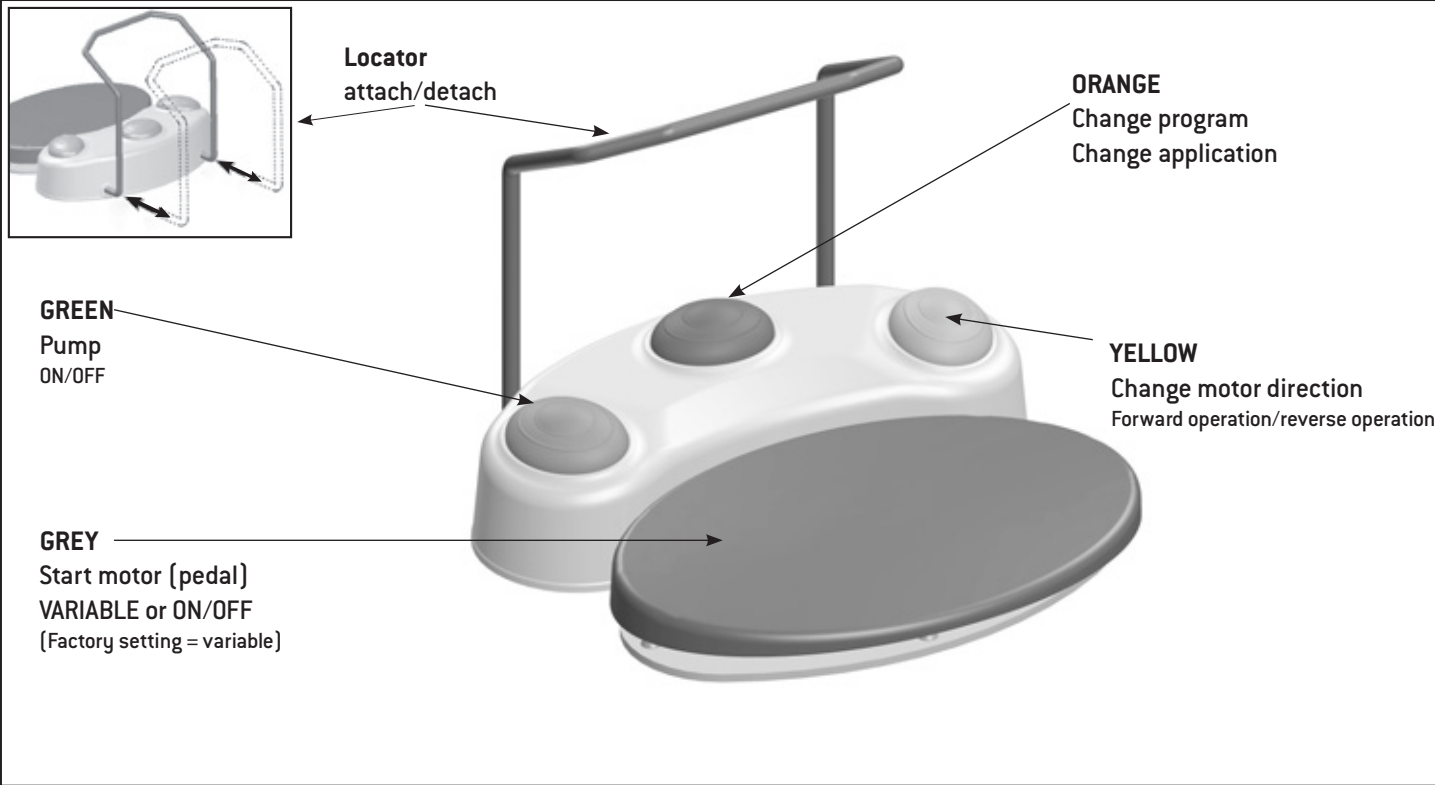

### **ORANGE**

#### **S-N2 / S-NW: Change program**

Press the ORANGE button to change programs in ascending order. The motor direction is automatically set to forward operation every time the program is changed.



When changing from the last program to the first program a longer acoustic signal sounds (risk of injury).

### **GREEN – pump ON/OFF**

Only when the motor is stationary can the pump be switched on or off by pressing the GREEN button of the foot control.

### **YELLOW – change motor direction**

#### **Forward operation/reverse operation**

Press the YELLOW button to change from forward operation to reverse operation. A signal sounds on selection and the “Forward/reverse operation mode” symbol flashes. Before the motor starts in reverse operation, 3 audible signals are given.

## 6. Start-up



Place the medical device on a flat level surface.



Ensure that the medical device can be disconnected from the power supply at any time.

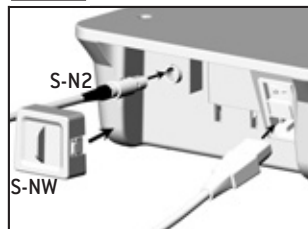

- 1** Connect the mains cable and foot control.

 Pay attention to the positioning!



- 2** Connect motor cable.

 Pay attention to the positioning!

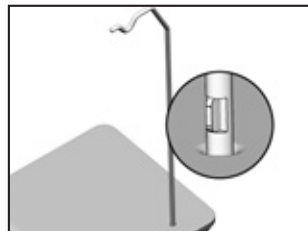

- 3** Insert the irrigant support.

 Pay attention to the positioning!  
(Maximum load capacity 1.5 kg)



- 4** Attach the universal support and lock it.

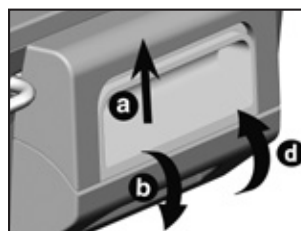

- 5** Insert the irrigation tubing.

> Open the pump cover (a,b).

> Insert the irrigation tubing (c).

> Close the pump cover (d).

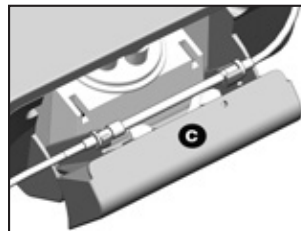

## Start-up



### Switching on the control unit

- 1 Plug the mains cable into an earthed power socket.



- 2 Switch on the control unit at the power switch.

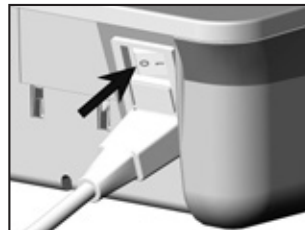

### Switching off the control unit

- 1 Switch off the control unit at the power switch.



- 2 Pull the power plug out of the socket.



The touch screen must only be touched using fingers.

Using hard objects on the touch screen may scratch or damage the surface.

### Setting up Implantmed

Switch on your control unit and follow the directions of the setup wizard.

The set-up wizard guides you through the various set-up stages up to the main menu:

> **Language selection**

> **Set Up Medical Device:**

Customized:          Create a user

Standard:             Default settings

## 8. Control unit operation

Main menu

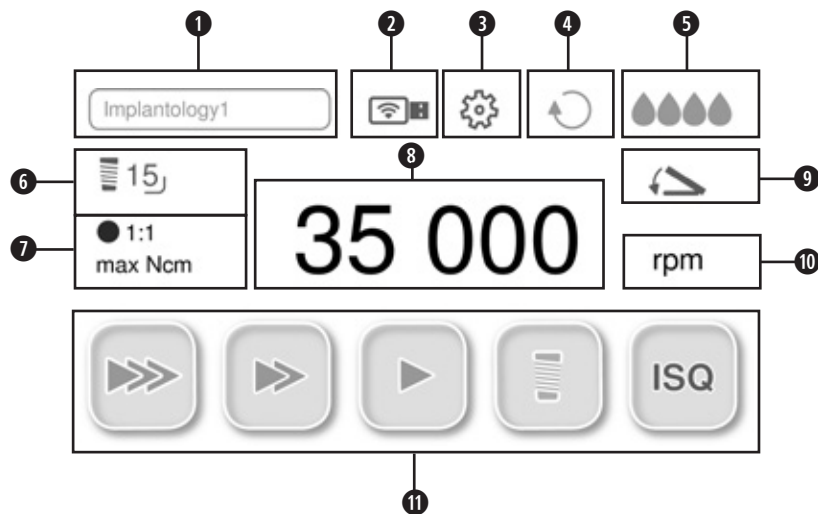

①	My favorites	⑦	Set program
②	Documentation / Wi-Fi Pairing	⑧	Set speed / torque
③	Setup	⑨	Foot control
④	Forward/reverse operation mode	⑩	Progress display mode
⑤	Set coolant volume	⑪	Programs
⑥	Tooth position		



# Control unit operation

---

## My favorites



### Select drill protocol group

An activated drill protocol cannot be deleted



### Edit

> Adjust factory setting of drill protocol groups.

> Create drill protocol



### Copy



### Rename



### Activate



### Delete

# Control unit operation

16  
● 1:1  
max. 50 Ncm

## Set program



### Transmission

### rpm Speed

At 40,000 rpm the accuracy of the set speed is  $\pm 10\%$ .

### Ncm Torque

Adjustment range 5 – 80 Ncm with WI-75 and WS-75 only.

Adjustment range 5 – 70 Ncm with SZ-75 only.

The motor switches off automatically when the set torque is reached in forward and reverse operation modes.

The accuracy of the set torque in the 20 – 50 Ncm range for the W&H WI-75, WS-75 and SZ-75 contra-angle handpieces is  $\pm 10\%$ . Greater deviations may be encountered with other contra-angle handpieces.



### Documentation

DOCU only appears once the documentation has been started.

rpm  
(Ncm)

## Progress display mode



### Bar



### Percent



### 100 Total

# Control unit operation

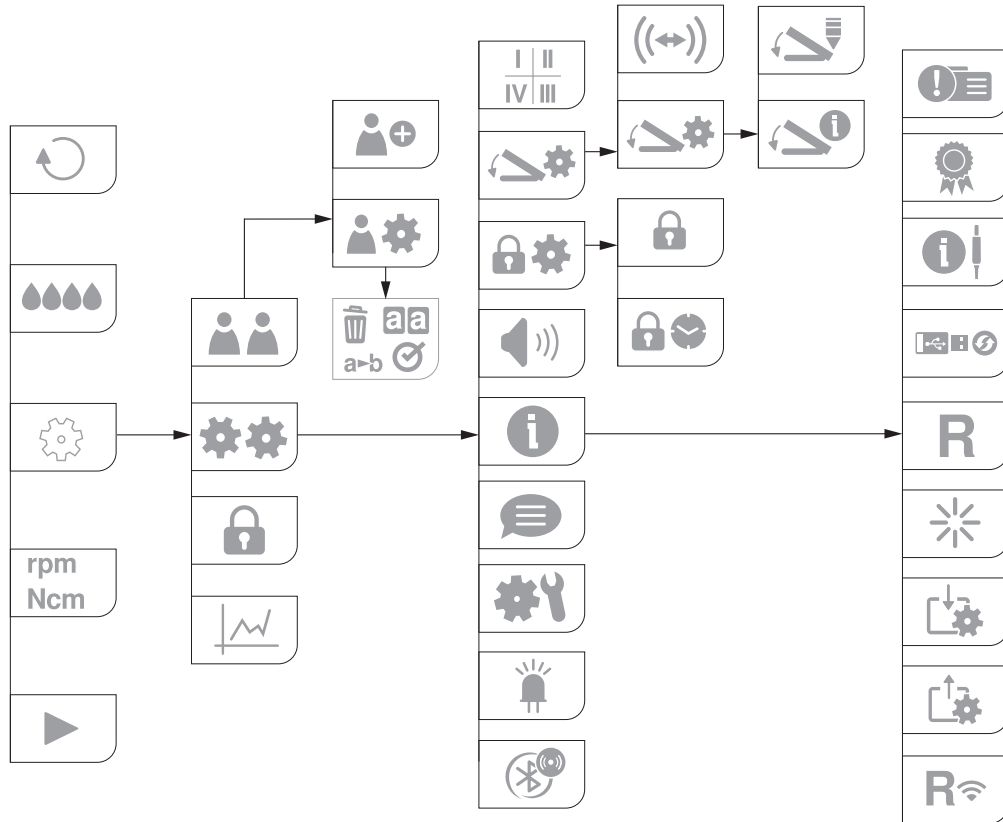
# Menu Navigation



# Control unit operation

 **User**  
 An activated user cannot be deleted

 **Add user**

 **Manage user**  
User settings: Copy, Rename, Activate, Delete

 **Foot control**

 **Pairing – S-NW**

 **Variable**

 **ON/OFF**

 **System**

 **Torque curve**

 **Set screen lock**  
Activating / deactivating screen lock

 **Screen lock**

 **Interval**  
Interval: Select time

 **LED**  
Activating / deactivating LED

 **Fade-out time**  
Select time

 **SOUND**  
Activating/deactivating

 **Language**  
Select language

# Control unit operation



## System check

Test run



## Dental numbering system

Select dental numbering system: FDI / UNS

I–IV

FDI (Fédération Dentaire Internationale = International dental numbering system)

1–32

UNS (Universal Numbering System = American dental numbering system)



Switch between selected tooth positions (green)



Selected tooth position (black)



New position



New docu



Complete docu



Wi-Fi-dongle



Device info



Service



Licenes

GPL: GNU General Public License

LGPL: GNU Lesser General Public License



Module info



Osstell



User interface



Motor control unit

# Control unit operation

---

 **Foot control**

 **Software update**

**R**  **Reset Wi-Fi pairing**

**R** **Reset**  
Restore factory settings

 **Restart**  
Control unit restarts automatically















 **Import user settings**

 **Export user settings**

 **Beacon**

 **Beacon Pairing**

## Control unit operation

-  Confirm/save
-  Favorite selected
-  black = information  
green = Information with selection option
-  red = error message, work cannot be continued  
orange = error message, work can be continued
-  red = replace batteries
-  Foot control S-NW
-  Foot control S-N2
-  Drill function
-  Drill function
-  Drill function
-  Thread-cutter function
-  Implant insertion
-  ISQ Implant stability quotient measurement
-  Torque indicator function (Counter clockwise)

### Thread-cutter function (chip breaker mode)



When the pedal (grey) on the foot control is pressed, the thread cutter rotates inwards until the set torque is reached. The control unit automatically switches to reverse operation when the set torque is reached. Disengaging and then re-engaging the pedal will switch the control unit back to forward operation.



If the thread cutter function is in reverse operation mode, the control unit can also start with the maximum torque.

### Torque indicator function (Counter clockwise)



Three signal tones sound when the function is activated. The function starts in reverse operation as standard. A signal tone sounds and the LED on the contra-angle handpiece flashes when the set torque is reached. The maximum torque that can be set varies depending on the speed selected.



 Drill protocols, torque curves and ISQ values can only be documented in the thread-tapping function, implant insertion or ISQ measurement.

Documentation must be activated or deactivated for each program.

A USB stick is required to save the documentation.



> Never remove the USB stick while the motor is running.

> Never remove the USB stick during the measurement.

### Record documentation

> Connect USB stick



Icon appears

> Enter ID

> Enter date

> Select tooth quadrant

> Select tooth

> Confirm selection



Documentation starts when the motor starts.

### Further documentation

-  > Add new position
- > Start new docu
- > Complete docu



When the motor stops, a diagram appears, which is automatically saved to the USB stick.

### Edit documentation

A text file (csv) and a PDF file are saved on the USB stick.  
The text file can be opened in Microsoft® Excel®\* for editing.  
The pdf file can be opened in Adobe® Reader®\*\*.

\* Microsoft® Excel® is a registered trademark of the Microsoft® Corporation in the United States of America and/or other countries.

\*\* Adobe® Reader® is a registered trademark of Adobe Systems Incorporated in the United States of America and/or other countries.



Follow the directions and safety notes in the Instructions for Use of the ioDent® platform.

**Check the data exchange between the ioDent® platform and the medical device.**



Check the transferred data for completeness and correctness.

**Establishing a connection to the ioDent® platform**

- > Insert the ioDent® Wi-Fi dongle
- > The connection is established



**The icon appears**

If the icon is green: The documentation is active

If the icon is grey: The system is connected

If the icon is yellow: There is a connection problem



When the motor stops, a diagram appears, which is automatically saved to the ioDent® platform.

 Connecting the medical device to an IT network or changing an IT network can lead to previously unidentified risks to patients, operators or third parties. The operator of the IT network is responsible for identification, analyzing, evaluating and controlling these risks. Changes to the IT-Network include changes in the IT-network configuration, connection of additional items to the IT-Network, disconnecting items from the IT- Network, update of equipment connected to the IT-Network, and upgrade of equipment connected to the IT-Network.

	Not paired device	Paired device
Device IP-address	192.168.10.1	192.168.10.x (from Gateway DHCP-Server)
Device communication port	443 (TLS/SSL)	443 (TLS/SSL)
Device subnet	255.255.255.0	255.255.255.0
Device hostname	Implantmed	Implantmed
Gateway IP	192.168.10.x	192.168.10.1

Used network layers/protocols		
Application	Application layer	https
Transport	Transport layer	SSL/TLS TCP
	Network layer	IPv4
	Data link layer	Wi-Fi (IEEE 802.11)



Follow the directions and safety notes in the Instructions for Use for the Beacon.

## Establishing a connection to the Beacon

Insert the Ostell dongle.

## Beacon pairing (standard)

- > Only possible in the ISQ program.
- > All Beacons connect to the medical device automatically.

## Beacon pairing using the serial number



- > Enter the serial number in the system settings.
- > Only the Beacon with the entered serial number can connect to the medical device.

## Deleting Beacon pairing

- > Enter 0 to delete the stored serial number.





## 9. Error messages









The error message disappears when it is clocked or when the pedal (grey) on the foot control is released.

Icon	Description of error	Solution
	WARNING FOOT CONTROL	<ul style="list-style-type: none"><li>&gt; Check plug contacts of foot control</li><li>&gt; Check the plug contacts of the dongle</li></ul>
	WARNING MOTOR	<ul style="list-style-type: none"><li>&gt; Check the plug contacts of the motor</li><li>&gt; Allow motor to cool for at least 20 minutes</li></ul>
	WARNING STORAGE DEVICE <ul style="list-style-type: none"><li>&gt; Insufficient memory available</li><li>&gt; Unknown file system</li><li>&gt; The write protection is active</li><li>&gt; Unknown storage device</li></ul>	<ul style="list-style-type: none"><li>&gt; Plug in a USB stick with sufficient memory</li></ul>
	WARNING OVERHEATING	<ul style="list-style-type: none"><li>&gt; Switch off the control unit</li><li>&gt; Allow the control unit to cool for at least 10 minutes</li><li>&gt; Switch on the control unit</li></ul>

## Error messages

Icon	Description of error	Solution
	WARNING TIME-OUT	<ul style="list-style-type: none"> <li>&gt; Release the pedal (grey) on the foot control</li> <li>&gt; Allow motor to cool for at least 20 minutes</li> </ul>
	SYSTEM ERROR	<ul style="list-style-type: none"> <li>&gt; Switch the control unit off and back on again</li> </ul> <p> If the error message appears again, contact an authorized W&amp;H service partner immediately.</p>
	SYSTEM NOT PAIRED	<ul style="list-style-type: none"> <li>&gt; System is not paired with the gateway.</li> <li>&gt; Please wait and if it occurs repeatedly contact an authorised service partner.</li> </ul>
	WARNING OSSTELL	<ul style="list-style-type: none"> <li>&gt; Remove the ISQ module and then assembly</li> <li>or</li> <li>&gt; Connect probe</li> <li>&gt; Remove probe from a source of electromagnetic interference</li> <li>&gt; Maintain a distance between the probe and the SmartPeg (3-5 mm)</li> <li>or</li> <li>&gt; Switch the control unit off and back on again</li> </ul>
	WARNING Wi-Fi CONNECTION	<ul style="list-style-type: none"> <li>&gt; Press the ioDent® Wi-Fi dongle symbol</li> <li>&gt; Attempt to establish a connection with the Wi-Fi gateway again.</li> </ul>

## Error messages

Icon	Description of error	Solution
	WARNING CONNECTION	<ul style="list-style-type: none"> <li>&gt; Press the ioDent® Wi-Fi dongle symbol</li> <li>&gt; Attempt to establish a connection with the ioDent® platform again.</li> </ul>
	WARNING DATA RECEPTION	<ul style="list-style-type: none"> <li>&gt; Restart the data transfer on the ioDent® platform.</li> </ul>
	WARNING TIME SYNCHRONISATION	<ul style="list-style-type: none"> <li>&gt; Restart the gateway</li> <li>&gt; Insert the ioDent® Wi-Fi dongle again</li> </ul>
	WARNING SYSTEM MONITORING	<ul style="list-style-type: none"> <li>&gt; Release the pedal (grey) on the foot control and press it again.</li> <li>&gt; If the error occurs again, restart the device.</li> </ul>
	WARNING IMPLANT DOCUMENTATION	<ul style="list-style-type: none"> <li>&gt; Maximum number of implants (8) for the active documentation has been reached.</li> </ul>
	WARNING DOCUMENTATION ACTIVE	<ul style="list-style-type: none"> <li>&gt; Finish the current documentation on the device before starting a new one.</li> </ul>
	WARNING SOFTWARE UPDATE FAILED	<ul style="list-style-type: none"> <li>&gt; Check the update files and copy the data to the USB stick again.</li> <li>&gt; Insert the USB stick again. Restart the update.</li> </ul>

- > If the described problem cannot be resolved, the unit will need to be inspected by an authorized W&H service partner.
- > In case of a total system failure, switch the control unit off and on again.





Follow your local and national laws, directives, standards and guidelines for cleaning, disinfection and sterilization.



Wear protective clothing, safety glasses, face mask and gloves.



Use only oil-free, filtered compressed air with a maximum operating pressure of 3 bar for manual drying.



### **Cleaning agents and disinfectants**

- > Read the notes, follow the instructions and heed the warnings provided by the manufacturers of cleaning agents and/or disinfectants.
- > Use only detergents which are intended for cleaning and/or disinfecting medical devices made of metal and plastic.
- > It is imperative to comply with the concentrations and exposure times specified by the manufacturer of the disinfectant.
- > Use disinfectants which have been tested and found effective by the Food and Drug Administration (FDA) and the U.S. Environmental Protection Agency (EPA).



The user is responsible for validating its process if the specified cleaning agents and disinfectants are not available.



The product lifetime and the medical device's ability to operate correctly are mainly determined by mechanical stress during use and chemical influences due to processing.

Send worn or damaged medical devices and/or medical devices with material changes to an authorized W&H service partner.



### **Processing cycles**

We recommend a regular service for the W&H universal support after 250 processing cycles.



- > Clean the medical device immediately after every treatment.
- > Wipe the control unit, the universal support and the irrigant support with disinfectant.

- ❶ Disconnect the power supply from the control unit. Check for any damage on the outer surface of each component.
- ❷ Lightly wipe all external surfaces of the control unit with a soft, lint-free cloth moistened with a neutral detergent for medical devices according to the manufacturer's instruction.
- ❸ Use a clean cloth moistened with disinfectant and wipe all surfaces. Make sure all surfaces remain visibly wet at room temperature for at least the minimum time specified in the instructions for use supplied by the disinfectant manufacturer.



Note that the disinfectant used during pre-treatment is only for personal protection and cannot replace the disinfectant step after cleaning.

## Universal support / Irrigant support



Do not immerse the medical product in liquid disinfectant or in an ultrasonic bath.

## Universal support / Irrigant support

- > Clean the universal support and the irrigant support under running tap water (< 35°C / < 95°F).
- > Rinse and brush off all internal and external surfaces.
- > Remove liquid residues using compressed air.

## Control unit



Do not immerse the medical device in water or clean it under running water.



Evidence of the medical device's basic suitability for effective manual cleaning was provided by an independent test laboratory using tap water < 35°C and towels/cloth »WIPEX® WET DESI premium« (NORDVLIES GmbH, Bargteheide).

- > Lightly wipe all external surfaces of the control unit with a soft, lint-free cloth moistened with a neutral detergent for medical devices. Clean surfaces until all visible soil is removed.
- > Remove the detergent from all surfaces using a lint-free cloth moistened with distilled water, deionized water, or demineralized water.



Evidence of the medical device's basic suitability for effective manual cleaning was provided by an independent test laboratory using the cleaning agent "LUMINOX®" (Alconox).

## Control unit / Universal support / Irrigant support



W&H recommends wipe-down disinfection.



Evidence of the basic suitability of the control unit, the universal support and the irrigant support for effective manual disinfection (intermediate level) was provided by an independent test laboratory using the disinfectant “CaviWipes™” (Metrex).

## Control unit



After removing all visible soil, use a clean cloth moistened with disinfectant and wipe all surfaces. Make sure all surfaces remain visibly wet at room temperature for at least the minimum time specified in the instructions for use supplied by the disinfectant manufacturer.

## Universal support / Irrigant support



W&H recommends automated cleaning and disinfection using a washer-disinfector (WD).  
Read the notes, follow the instructions and heed the warnings provided by the manufacturers of washer-disinfectors, cleaning agents and/or disinfectants.



The control unit is not approved for automated cleaning and disinfection.



Evidence of the basic suitability the universal support and the irrigant support for effective automated disinfection was provided by an independent test laboratory using the “Miele PG 8582 CD” washer-disinfector (Miele & Cie. KG, Gütersloh) and the “Dr. Weigert neodisher® MediClean forte” cleaning agent (Dr. Weigert GmbH & Co. KG, Hamburg) according to ISO 15883.

- > Cleaning at 55°C (131°F) – 5 minutes
- > Disinfection at 93°C (200°F) – 5 minutes



## **Universal support / Irrigant support**

- > Ensure that the universal support and the irrigant support are completely dry internally and externally after cleaning and disinfection.
- > Remove liquid residues using compressed air.

### Inspection – Universal support / Irrigant support



- > Check the medical device after cleaning and disinfection for damage, visible residual soiling and surface changes.
- > Reprocess any medical devices and stand that are still soiled.
- > Sterilize the universal support following cleaning and disinfection.



## Universal support



Pack the medical device in FDA sterilization packages that meet the following requirements:

- > The sterilization package must meet the applicable standards in respect of quality and use and must be suitable for the sterilization method.
- > The sterilization package must be large enough for the sterilization goods.
- > The filled sterilization package must not be under tension.

## Universal support



W&H recommends sterilization according to ANSI/AAMI ST55, ANSI/AAMI ST79.



- > Read the notes, follow the instructions and heed the warnings provided by the manufacturers of steam sterilizers.
- > The program selected must be suitable for the universal support.

## Recommended sterilization procedures

- > “Dynamic-air-removal cycle” (type B, S)  
132°C (270°F) for at least 4 minutes
- > “Gravity-displacement cycle” (type N)  
121°C (250°F) for at least 30 minutes
- > Maximum sterilization temperature 135°C (275°F)

 Evidence of the medical device's basic suitability for effective sterilization was provided by an independent test laboratory using the LISA 517 B17L\* steam sterilizer (W&H Sterilization S.r.l., Brusaporto (BG)) and the CertoClav MultiControl MC2-S09S273\*\* steam sterilizer (CertoClav GmbH, Traun).

“Dynamic-air-removal cycle”: 132°C (270°F) – 4 minutes\*/\*\*

“Gravity-displacement cycle”: 121°C (250°F) – 30 minutes\*\*

Minimum drying times:

“Dynamic-air-removal cycle”: 132°C (270°F) – 30 minutes\*\*

“Gravity-displacement cycle”: 121°C (250°F) – 30 minutes\*\*

\* EN 13060, EN 285, ISO 17665

\*\* ANSI/AAMI ST55, ANSI/AAMI ST79

## Universal support



- > Store sterile goods dust-free and dry.
- > The shelf life of the sterile goods depends on the storage conditions and type of packaging.

## 11. Servicing

---



### **Periodic inspection**

Regular periodic inspection of the function and safety of the medical device is necessary and should be carried out at least once every three years, unless shorter intervals are prescribed by law.

The periodic inspection covers the complete medical device and must only be performed by an authorized service partner.

# Servicing

---

## Repairs and returns

In the event of operating malfunctions immediately contact an authorized W&H service partner.  
Repairs and maintenance work must only be undertaken by an authorized W&H service partner.



Ensure that the medical device has been completely processed before returning it.



Always return equipment in the original packaging.

## 12. Accessories, consumables, spare parts and other recommended medical devices by W&H



Use only original W&H accessories and spare parts or accessories approved by W&H.

Suppliers: W&H partners (Link: <https://www.wh.com>)

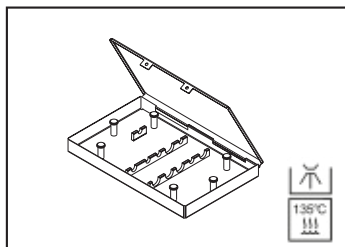

**04013500**

Cassette

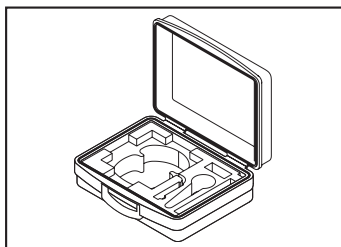

**07962790**

Transportation case



**07721800**

Universal support

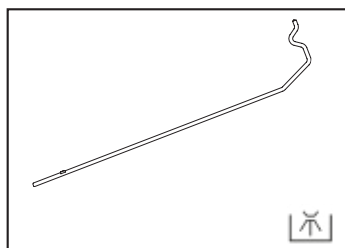

**04005900**

Irrigant support

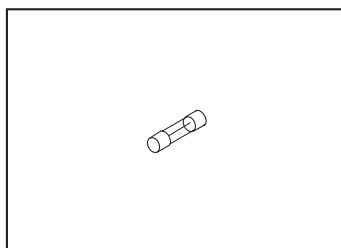

**06352200**

Fuse (250 V - T1.6AH)

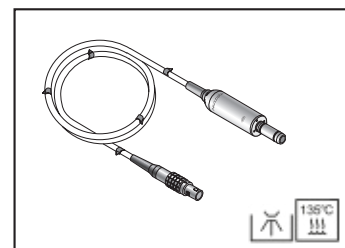

**3028100x**

EM-19 LC motor with electrical contacts and 1.8 m or 3.5 m cable

# Accessories, consumables, spare parts and other recommended medical devices by W&H

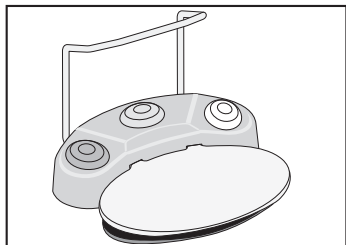

**30285000**

Foot control S-N2

**30264000**

Foot control S-NW

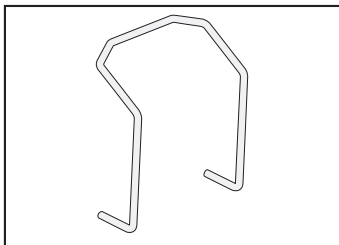

**04653500**

Locator for foot control

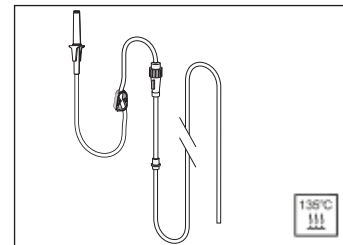

**04719400**

Irrigation tubing set 2.2 m

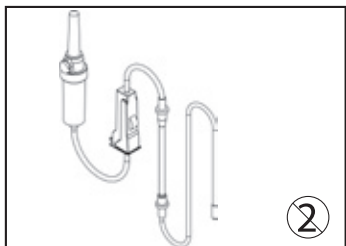

**04363600**

Irrigation tubing set 2.2 m (6 pcs)

**04364100**

Irrigation tubing set 3.8 m (6 pcs)

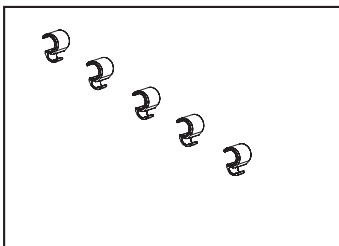

**06290600**

Hose clips (5 pcs)

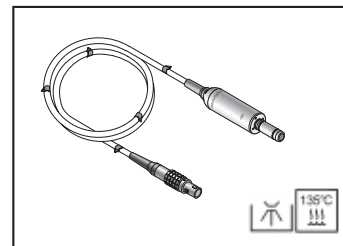

**30185000**

EM-19 motor without  
electrical contacts  
and 1.8 m cable



## Accessories, consumables, spare parts and other recommended medical devices by W&H



**08026120**

ioDent® Wi-Fi dongle



**08026150**

ioDent® gateway mini

Scan the QR code to find accessories, consumables and spare parts for this medical device.



## 13. Technical data

Control unit	SI-1023	SI-1015	SI-1010
Mains voltage:	230 V	120 V	100 V
Permissible voltage fluctuation:	220 – 240 V	110 – 130 V	90 – 110 V
Rated current:	0.3 – 0.8 A	0.3 – 1.6 A	0.3 – 1.4 A
Maximum power consumption:	170 VA		140 VA
Frequency:	50 – 60 Hz		
Mains fuse (2 pcs):	250 V – T1.6 AH		
Maximum power output:	80 W		
Maximum torque at motor:	6.2 Ncm		
Motor speed range in the rated voltage range:	200 – 40,000 rpm		
Coolant flow rate at 100%:	min. 90 ml/min		
Dimensions in mm (height x width x depth):	100 x 262 x 291		
Weight in kg:	3.5		

### Ambient conditions

Temperature during storage and transport:	-40°C to +70°C (-40°F to +158°F)
Humidity for storage and transport:	8 % to 80 % (relative), non-condensing
Temperature in operation:	+10°C to +35°C (+50°F to +95°F)
Humidity in operation:	15 % to 80 % (relative), non-condensing

## Technical data

---

**Classification according to Paragraph 6 of the General Specifications for the Safety of Medical Electrical Device according to IEC 60601-1/ANSI/AAMI ES 60601-1**



Class II medical electrical device (protective earth conductor used for functional earth connection only!)

Pollution level:

2

Overvoltage category:

II

Altitude:

up to 3,000 m above sea level

## 14. Data on electromagnetic compatibility according to IEC/EN 60601-1-2

---



### **Operating environment and EMC warning notes**

This medical device is neither life-sustaining nor coupled to the patient. It is suitable for operation both in domestic healthcare and in facilities used for medical purposes except rooms/areas, in which EMC interference of high-intensity may occur.

The customer and/or the user should assure that this medical device is set up and used in an environment of the specified type and/or in accordance with the specifications of the manufacturer. This medical device uses RF energy only for its internal functions. Therefore, its RF emissions are very low and not likely to cause any interference in nearby electronic equipment.

No special precautions are necessary to maintain the basic safety and essential performance of this medical device



### **Essential performance**

This medical device has no critical functions and therefore does not have any essential performance features.

## Data on electromagnetic compatibility according to IEC/EN 60601-1-2

---



### **RF communication equipment**

Portable RF communications equipment (including peripherals such as antenna cables and external antennas) should be used no closer than 30 cm (12 inches) to the medical device. Otherwise, degradation of the performance of this medical device could result.



W&H guarantees the compliance of the device with the EMC requirements only when used with original W&H accessories and spare parts. The use of accessories and spare parts not approved by W&H can lead to an increased emission of electromagnetic interference or to a reduced resistance against electromagnetic interference.



Use of this medical device adjacent to or stacked with other equipment should be avoided because it could result in improper operation. If such use is necessary, this medical device and the other equipment should be observed to verify that they are operating normally.



The medical device is not intended for use in the vicinity of HF surgical devices.

# Results of the electromagnetic tests

Requirement	Class / Test Level*	
<b>Electromagnetic emissions</b>		
Mains terminal disturbance voltage (Conducted Emissions) CISPR 11/EN 55011 [150 kHz – 30 MHz]	Group 1 Class B	
Electromagnetic radiation disturbance (Radiated Emissions) CISPR 11/EN 55011 [30 MHz – 1000 MHz]	Group 1 Class B	
Harmonic distortion IEC/EN 61000-3-2	Class A	
Voltage fluctuations and flicker IEC/EN 61000-3-3	–	
<b>Immunity to electromagnetic interference</b>		
Electrostatic discharge (ESD) IEC/EN 61000-4-2	Contact discharge: $\pm 2$ kV, $\pm 4$ kV, $\pm 6$ kV, $\pm 8$ kV Air discharge: $\pm 2$ kV, $\pm 4$ kV, $\pm 8$ kV, $\pm 15$ kV	
Radiated RF electromagnetic fields IEC/EN 61000-4-3 [80 MHz – 2,7 GHz]	10 V/m	
Proximity fields from RF wireless communications equipment IEC/EN 61000-4-3	710 / 745 / 780 / 5240 / 5500 / 5785 MHz	9 V/m
	385 MHz	27 V/m
	450 / 810 / 870 / 930 / 1720 / 1845 / 1970 / 2450 MHz	28 V/m
Electrical fast transients / bursts IEC/EN 61000-4-4	Mains supply: $\pm 2$ kV Input and output ports: $\pm 1$ kV	
Surges IEC/EN 61000-4-5	$\pm 1$ kV L – N	$\pm 2$ kV L – PE $\pm 2$ kV N – PE
Conducted disturbances induced by RF fields IEC/EN 61000-4-6	3 V 6 V in ISM bands and in amateur radio bands	
Power frequency magnetic fields IEC/EN 61000-4-8	30 A/m	
Voltage dips, short interruptions and voltage variations IEC/EN 61000-4-11	0% for 0.5 cycle at 45° steps from 0°-315° 0% for 1 cycle 70% for 25/30 cycles 0% for 250/300 cycles	
Proximity magnetic fields IEC/EN 61000-4-39	30 kHz	8 A/m
	134,2 kHz	65 A/m
	13,56 MHz	7,5 A/m

\* There are no deviations or simplifications to IEC/EN 60601-1-2.

## 15. Disposal

---



Ensure that the parts are not contaminated on disposal.



Follow your local and country-specific laws, directives, standards and guidelines for disposal.

- > Medical device
- > Waste electrical equipment
- > Packaging

# W&H course certificate

for the user

The user has been trained to use the medical device correctly in accordance with the legal regulations (medical devices marketing regulations, medical devices act). Particular attention has been paid to the chapters on safety notes, start-up, operation, hygiene and maintenance, and service (regular inspections).

Product name	Serial number (SN)
Manufacturer with address	
Distributor with address	

Name of the user	Date of birth and/or personnel number
Hospital/dental practice/department with address	
Signature of the user	
The signature confirms that the user has been trained to use the medical device and has understood the content.	

Name of the instructor	Date of instruction
Address of the instructor	
Signature of the instructor	





# W&H course certificate

for the instructor

The user has been trained to use the medical device correctly in accordance with the legal regulations (medical devices marketing regulations, medical devices act). Particular attention has been paid to the chapters on safety notes, start-up, operation, hygiene and maintenance, and service (regular inspections).

Product name	Serial number (SN)
Manufacturer with address	
Distributor with address	



Name of the user	Date of birth and/or personnel number
Hospital/dental practice/department with address	
Signature of the user	
The signature confirms that the user has been trained to use the medical device and has understood the content.	



Name of the instructor	Date of instruction
Address of the instructor	
Signature of the instructor	



# Explanation of warranty terms

This W&H medical device has been manufactured with great care by highly qualified specialists. A wide variety of tests and controls guarantees faultless operation. Please note that claims under warranty can only be validated when all the directions in the Instructions for Use have been followed.

**As the manufacturer, W&H is liable for material or manufacturing defects within a warranty period of 24 months from the date of purchase. Accessories and consumables are not covered by the warranty.**

We accept no responsibility for damage caused by incorrect handling or by repairs carried out by third parties not authorized to do so by W&H!

Claims under warranty accompanied by proof of purchase must be sent to the vendor or to an authorized W&H service partner. The provision of service under warranty extends neither the warranty period nor any other guarantee period.

**24 months warranty**

## Authorized W&H service partners

---

Find your nearest authorized W&H service partner at <http://wh.com>  
Simply go to the menu option “Service” for full details.

Or simply scan the QR code.







**W&H Dentalwerk Bürmoos GmbH**  
**Ignaz-Glaser-Straße 53, 5111 Bürmoos, Austria**

**t +43 6274 6236-0,    f +43 6274 6236-55**  
**office@wh.com        wh.com**

**Form Nr. 50873 AAE**  
**Rev. 009 / 19.08.2024**  
**Software version 1.X.X.**  
**Subject to alterations**