

# Instructions for Use



CE  
0297

**Electric Motor**  
**MF-100**

# Contents

---

Symbols.....	3 – 4
1. Introduction.....	5 – 6
2. Electromagnetic compatibility (EMC) .....	7
3. Unpacking.....	8
4. Scope of delivery.....	9
5. Safety notes .....	10 – 12
6. Guide to display .....	13
7. Installing the support.....	14
8. How to remove the display – Installing the display / bracket .....	15
9. Overview of the rear .....	16
10. Start-up – General .....	17
11. Factory settings / keys .....	18
12. Operation – Changing / saving the speed.....	19
13. Operation – Changing from forward to reverse operation and saving the setting.....	20
14. Operation – General set-up menu.....	21
15. Operation – Back to original program .....	22
16. Reset factory settings.....	22
17. Operation – Set-up menu .....	23
18. Deactivate standby mode.....	24
19. Error messages.....	25
20. Hygiene and maintenance.....	26 – 27
21. W&H Accessories.....	28
22. Servicing .....	29
23. Technical data.....	30
24. Disposal .....	31
Explanation of warranty terms .....	32
Authorised W&H service partners.....	33

# Symbols

## Symbols in the Instructions for Use



**WARNING!**  
(risk of injury)



**ATTENTION!**  
(in cases where something could  
be damaged)



General explanations,  
without risk to  
persons or property

## Symbols on the medical device



Consult instructions for use



Catalogue number



Data matrix code



Follow instructions for use



Serial number



Supply voltage  
of the medical device



Date of manufacture



Do not dispose of with  
domestic waste



Type B applied part  
(not suitable for intracardiac  
application)



Medical – General medical equipment with respect to electrical shock, fire and mechanical hazards only in accordance with UL 60601-1:2006, CAN/CSA-C22.2 No. 601.1-M90:2005, CAN/CSA-C22.2 No. 60601-1:2008, ANSI/AAMI ES 60601-1:2005. 25UX (Control No.)

# Symbols on the packaging

 CE marking  
with identification number  
of the Notified Body

 This way up

 Fragile, handle with care

 Keep dry

 »Der Grüne Punkt« (The Green Dot)  
trademark of Duales System  
Deutschland GmbH

 Trademark of RESY OfW GmbH  
for identification of recyclable  
transport and outer packaging  
of paper and cardboard



DataMatrix Code  
for product information including UDI  
(Unique Device Identification)



Data structure in accordance with  
Health Industry Bar Code

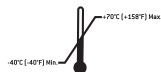

Permitted  
temperature rang



Humidity,  
Limitation

**R<sub>x</sub>**only

Caution! Federal law restricts this device to sale by  
or on the order of a dentist, physician or any other  
practitioner licensed by the law of the state in which he  
or she practices to use or order the use of the device.

# 1. Introduction

---



## **For your safety and the safety of your patients**

These Instructions for use explain how to use your medical device. However, we must also warn against possible hazardous situations. Your safety, the safety of your team and, of course, the safety of your patients are of paramount importance to us.



Observe the safety notes on pages 10 to 12.

## **Intended use**

Electrical drive including media supply for dental handpieces in the field of preventative dentistry, conservative dentistry for tasks such as the preparation of cavities and prosthodontics for tasks such as the preparation of crowns.



Misuse may damage the medical device and hence cause risks and hazards for patients, users and third parties.

## **Qualifications of the user**

We have based our development and design the medical device on the dentist, dental hygienist, dental employees (prophylaxis) and dental assistants target group.

# 1. Introduction

---



## **Production according to EU Directive**

The medical device meets the requirements of Directive 93/42/EEC.



## **Responsibility of the manufacturer**

The manufacturer can only accept responsibility for the safety, reliability and performance of the medical device if it is used in compliance with the following directions:

- > The medical device must be used in accordance with these Instructions for use.
- > The medical device has no components that can be repaired by the user. Assembly, modifications or repairs must only be undertaken by an authorised W&H service partner (page 33).
- > The electrical installation at the premises must comply with the regulations laid out in IEC 60364-7-710 (»Installation of electrical equipment in rooms used for medical purposes«) or with the regulations applicable in your country.
- > Unauthorised opening of the equipment invalidates all claims under warranty and any other claims.

## 2. Electromagnetic compatibility (EMC)

---



Medical electrical equipment is subject to particular precautions with regards to EMC and must be installed and put into operation in accordance with the EMC notes included.

W&H guarantees the compliance of the device with the EMC requirements only when used with original W&H accessories and spare parts. The use of accessories and spare parts not approved by W&H can lead to an increased emission of electromagnetic interference or to a reduced resistance against electromagnetic interference.



You can find the current EMC manufacturer's declaration on our website at <http://wh.com> or request a copy directly from the manufacturer.



### **HF communication equipment**

Do not use any portable and mobile HF communication equipment (such as e.g., mobile telephones) during operation. These may affect medical electrical equipment.

### 3. Unpacking

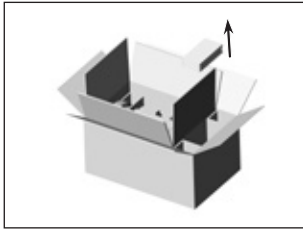

- 1 Remove the electric motor and the accessories [optional].

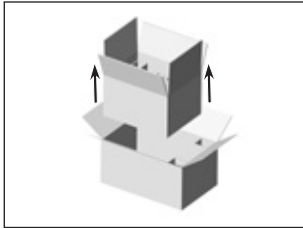

- 2 Lift out the complete insert.

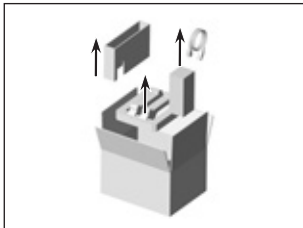

- 3 Remove the insert of the hose and the protective packaging for the supply unit. Remove the power supply unit and the mains cable.

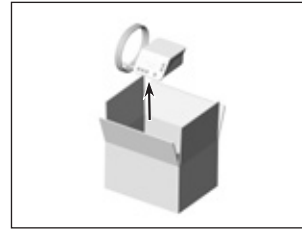

- 4 Remove the power supply unit and the hose.

W&H packaging is environmentally friendly and can be disposed of by industrial recycling companies.

However, we recommend that you keep the original packaging.



## 4. Scope of delivery

---

**REF 30241000** Control unit

REF 07883900 Power supply unit

REF 30178000 Electric motor EM-12 L

Hose fixing

### **Mains cable**

REF 01343700 (EU)

REF 04280600 (CH)

REF 05901800 (DK)

REF 02821400 (USA, CAN, J)

REF 03212700 (UK, IRL)

REF 02909300 (AUS, NZ)

REF 05333500(BR)

## 5. Safety notes

---



- > Before using the medical device for the first time, store it at room temperature for 24 hours.
- > Only use the mains cable REF 07883900.
- > Only connect the mains cable to grounded socket outlets.
- > Check the medical device and the instrument with cable for damage and loose parts each time before using. Correct any faults or refer to an authorised W&H service partner (see page 33).
- > Check the settings every time the medical device is restarted.
- > Do not operate the medical device if it is damaged.
- > Always ensure the correct operating conditions and cooling function.
- > Always ensure that sufficient and adequate cooling is delivered and ensure adequate suction.
- > Perform a test run each time before using.
- > Run the rinsing function of the dental unit once a day
- > Follow the instructions and safety notes in the instructions for use of the electric motor.



- > Operation is only permitted on dental units that conform to the IEC 60601-1 (EN 60601-1) and IEC 60601-1-2 (EN 60601-1-2) standards.



### **Inappropriate use**

In addition to unauthorised assembly, installation, modification or repairs to the medical device and non-compliance with our instructions, invalidates all claims under warranty and any other claims.

## 5. Safety notes

---



### **Danger zones M and G**

In accordance with IEC 60601-1 / ANSI/AAMI ES 60601-1, the medical device is not suitable for use in potentially explosive atmospheres or with potentially explosive mixtures of anaesthetic substances containing oxygen or nitrous oxide.



The medical device is not suitable for use in oxygen-enriched atmospheres.



**Zone M**, also referred to as the “medical environment”, includes the part of a room in which potentially explosive atmospheres may occur as a result of the use of analgesics or medical skin cleaning or disinfectants agents, but only in small quantities and only for a short time. Zone M comprises a truncated pyramid below the operating table which is tilted outwards at a 30° angle.



**Zone G**, also referred to as an “enclosed medical gas system”, comprises not necessarily fully enclosed cavities in which permanent or temporary potentially explosive mixtures may be generated, supplied or used in small quantities.



### **Risks due to electromagnetic fields**

The functionality of implantable systems, such as cardiac pacemakers and implantable cardioverter defibrillator (ICD) can be affected by electric, magnetic and electromagnetic fields.

- > Find out if patient and user have implanted systems before using the medical device and consider the application.
- > Weigh the risks and benefits.
- > Keep the medical device away from implanted systems.

## 5. Safety notes

---



- > Make appropriate emergency provisions and take immediate action on any signs of ill-health.
- > Symptoms such as raised heartbeat, irregular pulse and dizziness can be signs of a problem with a cardiac pacemaker or ICD.



### **Medical device**

The medical device is classed as “conventional equipment” (closed equipment without protection against the ingress of water).

### **Power supply unit**

Only use the power supply unit supplied.

### **Mains cable**

Only use the mains cable supplied.

Plug the mains cable only into a earthed power socket.



### **Disconnect the medical device in dangerous situations from the power supply.**

- > Pull the power plug out of the socket.

### **System failure**

A total system failure does not constitute a critical fault.

- > Simply disconnect the medical device and then connect again.

# 6. Guide to display

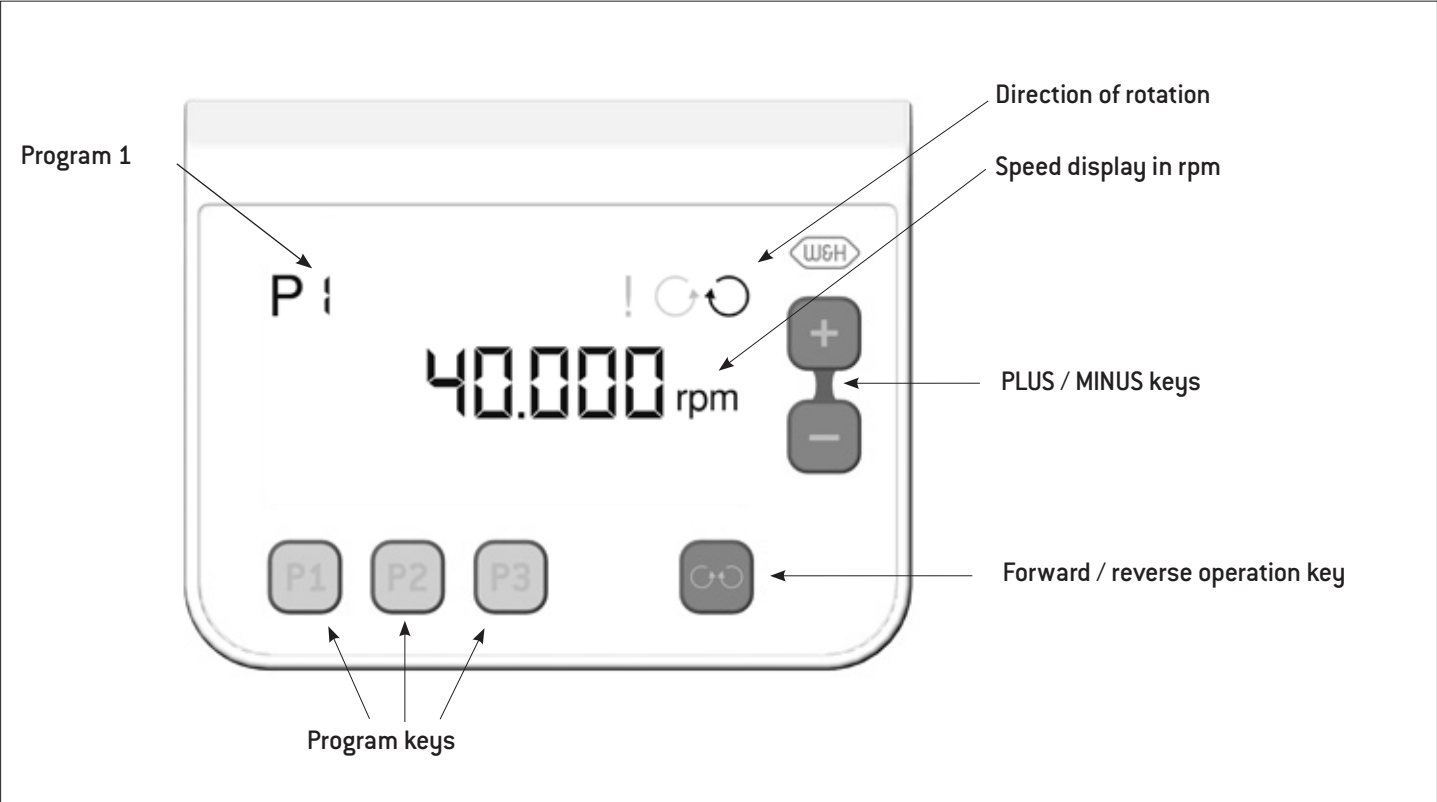

## 7. Installing the support

Installation example

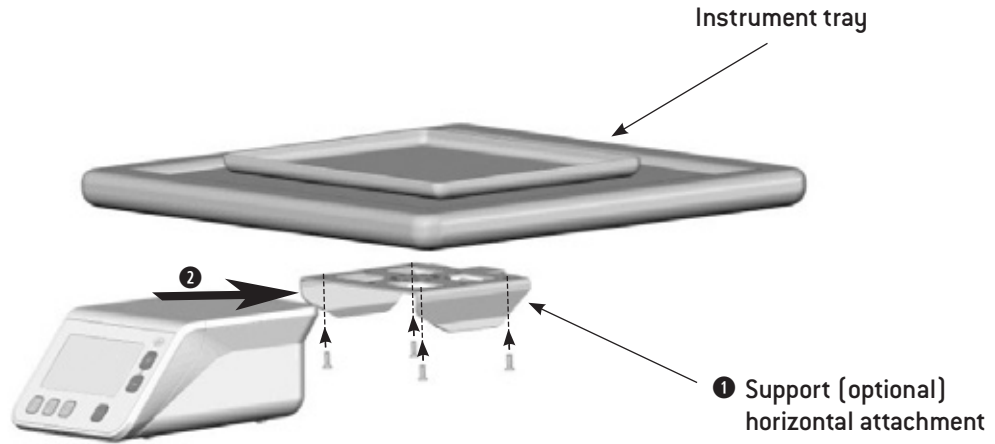

## 8. How to remove the display – Installing the display / bracket

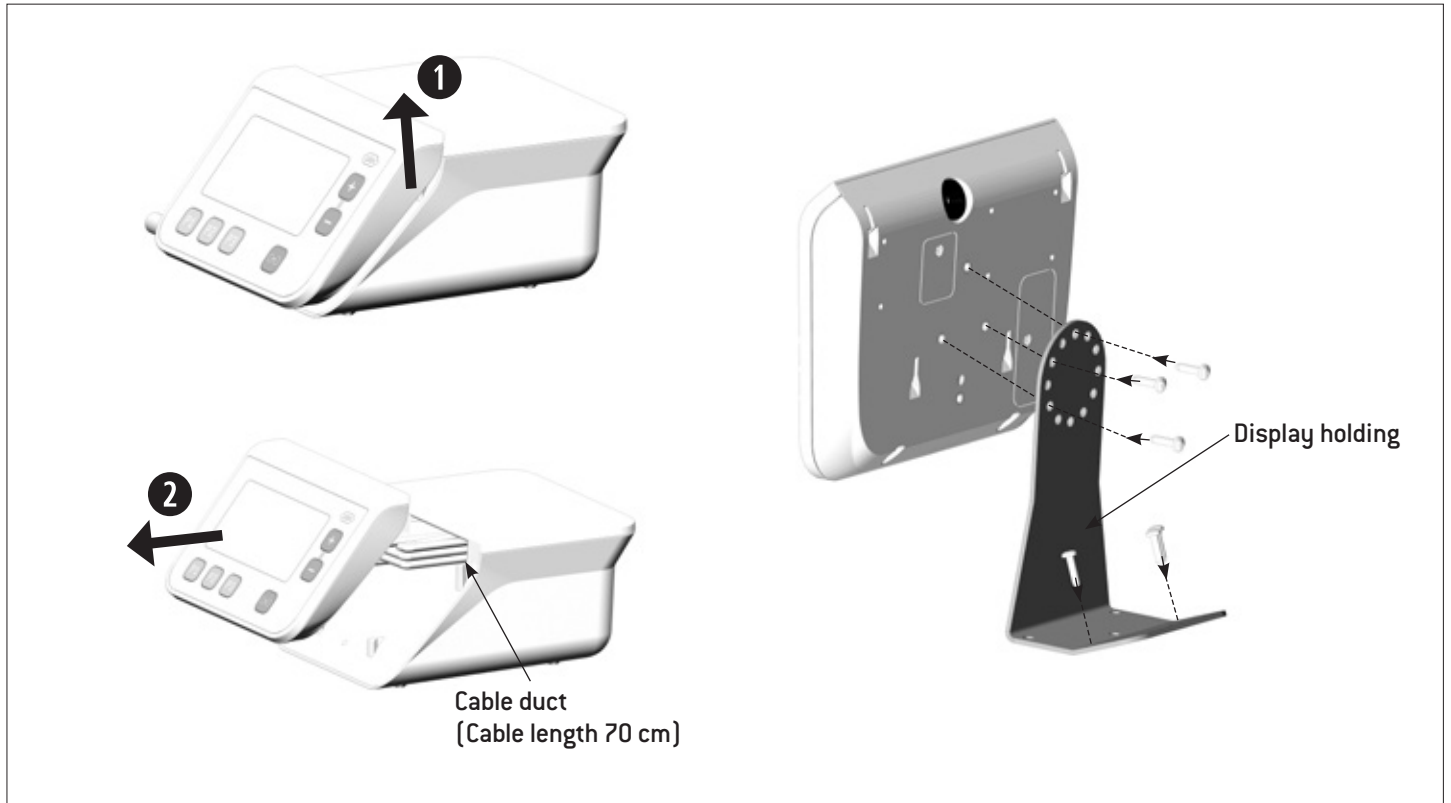

## 9. Overview of the rear

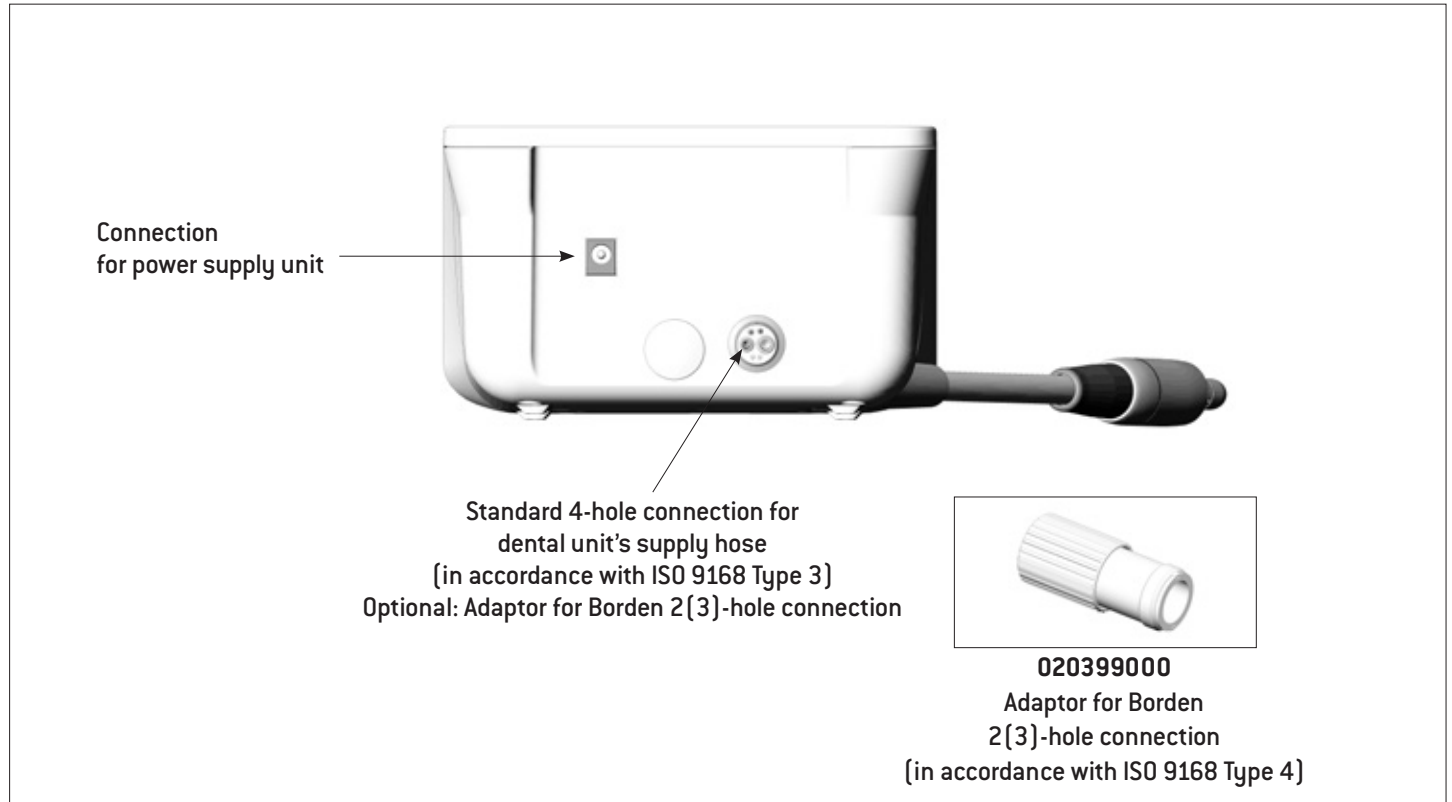





## 10. Start-up – General

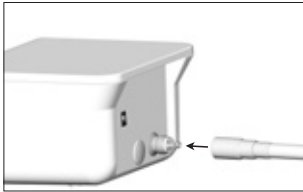

Ensure that the medical device can be disconnected from the power supply at any time.



- 1 Screw on dental unit's supply hose (in accordance with ISO 9168 Type 3).

 Pay attention to the positioning!

Optional: Adaptor for Borden 2(3)-hole connection

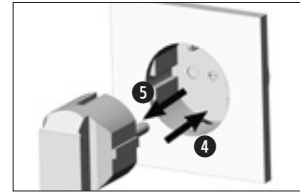

- 4 Plug the mains cable into a earthed power socket (90 – 264 V AC, 47 – 63 Hz)

- 5 Pull the power plug out of the socket.



- 2 Connect the mains cable to the medical device.



- 6 Attach the motor.

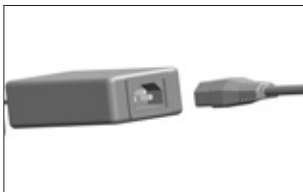

- 3 Connect the mains cable to the power supply unit.



- 7 Hose fixing for dental units with whip arm system

## 11. Factory settings / keys

 **Program 1 – Display shows P1:**  
Forward drive 40,000 rpm

 **Program 2 – Display shows P2:**  
Forward drive 20,000 rpm

 **Program 3 – Display shows P3:**  
Forward drive 2,000 rpm



The display shows the speed of the motor.



Note the transmission / reduction ratio of the transmission instrument.

> The speed of the instrument (e. g. rotary instrument) depends on the transmission instrument used.

 **PLUS key**

Increase speed to max. 40,000 rpm, possible during use

 **MINUS key**

Reduce speed to min. 2,000 rpm, possible during use

 **Forward/reverse key**

Changing from forward to reverse operation.

## 12. Operation – Changing / saving the speed

---



The speed can be set at P1, P2 or P3 from minimum 2,000 rpm to maximum 40,000 rpm.



① Press the program key (P1, P2 or P3).



② Increase speed



③ Reduce speed



④ Press the program key (P1, P2 or P3) for approximately 2 seconds to save.



The set values flash and an acoustic signal is emitted to confirm that all the settings have been saved.



## 13. Operation – Changing from forward to reverse operation and saving the setting

 Factory setting = Forward operation



❶ Press the forward/reverse operation key.



»!« and  appear on the display and an acoustic signal is emitted.  
»!« and  flash continuously.

An acoustic signal is emitted three times in succession before the motor is started in reverse operation via the foot control.



❷ Press program key (P1, P2 or P3) for approx. 2 seconds to save.



If the program settings are not saved in reverse operation, the device will switch back to forward operation automatically when you change programs.

## 14. Operation – General set-up menu

---



You can return to the set-up menu from any program by pressing on the PLUS and MINUS keys at the same time.



- 1 Press the PLUS and MINUS keys simultaneously for approximately 3 seconds.  
»Setup« appears on the display.



- 2 Press program key P1 to navigate in the set-up menu.



- 3 Press the PLUS / MINUS key to change the setting in the respective set-up menu item.



- 4 Press program key P1 for approximately 3 seconds to save.



The set values display flash and an acoustic signal is emitted to confirm that all the settings have been saved.

## 15. Operation – Back to original program

---



Press the PLUS and MINUS keys simultaneously for approximately 3 seconds to exit the set-up menu.



The original program appears on the display.

## 16. Reset factory settings

---



Press program keys P1, P2 and P3 simultaneously for approximately 3 seconds [ see page 18 ].

## 17. Operation – Set-up menu

### »Pedal«

- > Pedal: ON/OFF
- > Pedal STEP: variable from 2,000 rpm to value set (maximum 40,000 rpm)

### »Sound«

- > Sound: ON
- > Sound: OFF

### »Speed«

- > rpm = absolute speed in rpm
- > % = speed displayed as a percentage
- P1 100 %
- P2 50 %
- P 3 5 %

Speed rpm	%
40.000	100 %
30.000	75 %
20.000	50 %
10.000	25 %
4.000	10 %
2.000	5 %

### »LED«

- > Setting for fade-out time: from 0 to maximum 60 seconds
- Factory setting = 5 seconds



## 18. Deactivate standby mode

---



You can exit standby mode by actuating the foot control or pressing the keys.



## 19. Error messages

Display	Description of error	Solutions
Error 1	Overheating/overloading of electronics	<ul style="list-style-type: none"> <li>&gt; ❶ Disconnect medical device from power supply</li> <li>    ❷ Wait 5 min. and allow the system to cool</li> <li>    ❸ Switch the medical device back on again and restart the function</li> </ul>
Error 2	Pedal of the foot control pressed during switching on	> Do not press the pedal of the foot control
Error 4	Display keys pressed during switching on	> Do not press the display keys
Error 5	Running time limiter as a result of 15 minutes of continuous operation	<ul style="list-style-type: none"> <li>&gt; Check pedal of the foot control</li> <li>&gt; Do not press pedal of the foot control any more [release completely]</li> </ul>
Error 6	Error in the »electric motor« applied part	<ul style="list-style-type: none"> <li>&gt; ❶ Check that the electric motor is correctly attached to the supply hose union</li> <li>&gt; ❷ Replace the electric motor</li> </ul>
Reboot		<ul style="list-style-type: none"> <li>&gt; Switch the power supply off and on again</li> <li>&gt; Restart system</li> </ul>
Error	e.g., 05 6303	> Contact an authorised W&H service partner immediately [see page 33].

If the error messages described cannot be resolved a check by an authorised W&H service partner is required [see page 33].

## 20. Hygiene and maintenance

---



Follow your local and national laws, directives, standards and guidelines for cleaning and disinfection.



- > Wear protective clothing.
- > Clean and disinfect the medical device **immediately after every treatment.**

### Medical device



- > The medical device is not approved for mechanical cleaning (thermo washer disinfectant) and sterilization.
- > Do not immerse the medical device in water or clean it under running water.

### Pre-disinfection

> If heavily soiled, clean first with disinfectant cloths.



Only use disinfectants that have no protein-fixing effects.

### Manual cleaning and disinfection

The display of the medical device is sealed and can be wiped.



W&H recommends wiping down with disinfectant.

Use only disinfectants which do not contain chlorine and which are certified by officially recognized institutes.

Note the manufacturer's specifications for the use of the disinfectants.

## 20. Hygiene and maintenance

---

### Before resuming operation

- > Wait until the medical device is completely dry.



Moisture in the plug can lead to a malfunction. (Risk of short circuit)

### Cable, hose



Do not twist or kink the cable! Do not coil it too tightly!



The supply hose is not approved for mechanical cleaning (thermo washer disinfectant) and sterilization.

### Pre-disinfection

- > If heavily soiled, clean first with disinfectant cloths.



Only use disinfectants that have no protein-fixing effects.

Use only disinfectants which do not contain chlorine and which are certified by officially recognized institutes.  
Note the manufacturer's specifications for the use of the disinfectants.

## 21. W&H Accessories



Use only original W&H accessories and spare parts or accessories approved by W&H.

Suppliers: W&H Partner

REF 07883900

Power supply unit

REF 30178000

Electric motor EM-12L

REF 07912400

Screw kit



**020399000**

Adaptor for Borden  
2(3)-hole connection



**07712700**

Display holding  
with Screw kit

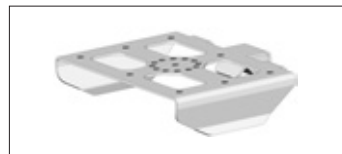

**07842200**

Support  
with Screw kit



**07944590**

Tray

## 22. Servicing

---



### **Regular checking of the medical device and accessories**

Regular servicing including the accessories is necessary and should be carried out at least once every three years, unless shorter intervals are prescribed by law.

The inspection must be undertaken by a qualified organisation and must include the following procedures:

- > Visual inspection for external damage
- > Check for any changes which could jeopardise safety
- > Measurement of the device leakage current
- > Measurement of the patient leakage current
- > Visual inspection of internal components on suspicion of safety interference, e.g., mechanical damage of the enclosure or indicators of overheating
- > Check of whether the correct power supply unit is being used



The regular service must only be performed by an authorised W&H service partner (see page 33).

### **Repair**

If a defect occurs, always return all the equipment, as it is also necessary to inspect all of the control electronics!

### **Returns**

- > Refer all questions to an authorized W&H service partner (see page 33).
- > Always return equipment in the original packaging!
- > Do not twist or kink the cable! Do not coil it too tightly! (Risk of damage)

## 23. Technical data

<b>Model</b>	<b>MF-100</b>
Power supply:	30 – 32 V 
Mains voltage:	100 – 240 V
Dimensions in mm (WxDxH):	156 x 211 x 92
<b>ISO 9168 supply connection</b>	
Forced air pressure:	3 ± 0.3 bar
Water pressure:	0.5 to 3 bar
Chip air pressure:	0.5 to 3 bar

### Ambient conditions

Temperature during storage and transport:	-40 °C to +70 °C
Humidity for storage and transport:	8 % to 80 % (relative), non-condensing
Temperature in operation:	+10 °C to 35 °C
Humidity in operation:	15 % to 80 % (relative), non-condensing
Permitted ambient pressure:	70 – 106 kPa
Pollution level:	2
Overvoltage category:	II
Altitude:	Up to 3,000 m above sea level

**Classification according to Paragraph 6 of the General Specifications for the Safety of Medical Electrical Equipment according to IEC 60601-1 / ANSI/AAMI ES 60601-1**



Type B applied part (not suitable for intracardiac application)

## 24. Disposal

---



Ensure that the parts are not contaminated on disposal.



Follow your local and national laws, directives, standards and guidelines for the disposal.

> Waste electrical equipment



> Packaging

# Explanation of warranty terms

This W&H medical device has been manufactured with great care by highly qualified specialists. A wide variety of tests and controls guarantees faultless operation. Please note that claims under warranty can only be validated when all the directions in the Instructions for use have been followed.

**As the manufacturer, W&H is liable for material or manufacturing defects within a warranty period of 24 months from the date of purchase. Accessories and consumables (RM seal) are excluded from the warranty.**

We accept no responsibility for damage caused by incorrect handling or by repairs carried out by third parties not authorized to do so by W&H!

Claims under warranty – accompanied by proof of purchase – must be sent to the vendor or to an authorized W&H service partner. The provision of service under warranty extends neither the warranty period nor any other guarantee period.

**24** months warranty



## Authorised W&H service partners

---

Find your nearest authorized W&H service partner at <http://wh.com>  
Simply go to the menu option “Service” for full details.

Or simply scan the QR code.



**Manufacturer**

**W&H Dentalwerk Bürmoos GmbH**  
Ignaz-Glaser-Straße 53, 5111 Bürmoos, Austria

**t +43 6274 6236-0, f +43 6274 6236-55**  
office@wh.com    **wh.com**

**Form-Nr. 50862 AEN**  
**Rev. 003 / 03.10.2024**  
**Subject to alterations**