

Instructions for use



CE
0297



synea^{FUSION}

Straight handpiece
HG-43 A

Contra-angle handpieces with light
WG-900 LT, WG-99 LT, WG-56 LT, WG-57 LT, WG-66 LT

Contra-angle handpieces without light
WG-900 A, WG-99 A, WG-56 A, WG-66 A

Contents

Symbols	4
in the Instructions for use	4
on the medical device / packaging.....	5
1. Introduction	6
2. Safety notes	9
3. Product description	12
4. Operation	14
Assembly / Removal	14
To change the rotary instrument.....	16
Test run	19
5. Hygiene and maintenance	20
General notes	20
Limitations on processing.....	22
Initial treatment at the point of use.....	23

Manual cleaning.....	24
Manual disinfection	27
Automated cleaning and disinfection.....	28
Drying.....	29
Inspection, Maintenance and Testing.....	30
Packaging.....	34
Sterilization	35
Storage.....	38
6. Servicing	39
7. Accessories, consumables, spare parts and other recommended medical devices by W&H	40
8. Technical data.....	41
9. Disposal	45
Explanation of warranty terms.....	46
Authorized W&H service partners	47



WARNING!
(risk of injury)



ATTENTION!
(to prevent
damage occurring)















General explanations,
without risk to
persons or objects



Do not dispose of
with domestic waste

Symbols

on the medical device / packaging

	CE marking with identification number of the Notified Body		DataMatrix Code for product information including UDI (Unique Device Identification)		Data structure in accordance with Health Industry Bar Code
	Catalogue number				Medical Device
	Serial number		Sterilizable up to the stated temperature		UL Component Recognition Mark indicates compliance with Canadian and U.S. requirements
	Date of manufacture		Thermo washer disinfectable		
	Manufacturer		Caution! Federal law restricts this device to sale by or on the order of a dentist, physician, veterinarian or with the descriptive designation of any other practitioner licensed by the law of the State in which the practitioner practices to use or order the use of the device.		
	Consult Instructions for use				

1. Introduction

Customer satisfaction has absolute priority in the W&H quality policy. This medical device has been developed, manufactured and subjected to final inspection according to legal regulations, quality and industry standards.

For your safety and the safety of your patients

Prior to initial use please read the Instructions for use. These explain how to use your medical device and guarantee a smooth and efficient operation.



Observe the safety notes.

Intended use / indications for use (only for USA)

The dental handpiece/contra-angle is intended for the following applications: Removal of decayed materials, cavities and crown preparation, removal of fillings, finishing and polishing of tooth and restoration surfaces.



Misuse may damage the medical device and hence cause risks and hazards for patient, user and third parties.



Qualifications of the user

We have based our development and design of the medical device on the dentists, dental hygienists, dental employees (prophylaxis) and dental assistants target group.

Responsibility of the manufacturer

The manufacturer can only accept responsibility for the safety, reliability and performance of the medical device when it is used in compliance with the following directions:

- > The medical device must be used in accordance with these Instructions for use.
- > The medical device has no components that can be repaired by the user.
- > Modifications or repairs must only be undertaken by an authorized W&H service partner (see page 47).



Skilled application

The medical device is intended only for skilled application according to the intended use as well as in compliance with the valid health and safety at work regulations, the valid accident prevention regulations and in compliance with these Instructions for use.

The medical device should be prepared for use and maintained by staff who have been trained in procedures for infection control, personal safety and patient safety.

Improper use, (e.g., through poor hygiene and maintenance), non-compliance with our instructions or the use of accessories and spare parts which are not approved by W&H, invalidates all claims under warranty and any other claims.



Any serious incident that has occurred in relation to the medical device should be reported to the manufacturer and the competent authority!

2. Safety notes



- > Always ensure the correct operating conditions and cooling function.
- > Always ensure that sufficient and adequate cooling is delivered and ensure adequate suction.
- > In case of coolant supply failure, the medical device must be stopped immediately.
- > Use only filtered, oil-free and cooled air supplied by dental compressors to operate the medical device.
- > Check the medical device for damage and loose parts each time before using.
- > Do not operate the medical device if it is damaged.
- > Perform a test run each time before using.
- > Avoid overheating at the treatment site.
- > Do not lift the cheek or tongue with the medical device. Risk of burning due to the push-button heating up!
- > Do not touch the soft tissue with the head of the medical device. Risk of burning if the medical device overheats!
- > It is imperative to comply with the concentrations and exposure times specified by the manufacturer of the treatment water decontamination system, as well as its handling.



- > Before using the medical device for the first time, store it at room temperature for 24 hours.
- > The operation of the medical device is permitted only on supply units which correspond to the standards IEC 60601-1 (EN 60601-1) and IEC 60601-1-2 (EN 60601-1-2).

Hygiene and maintenance prior to initial use



- > The medical device is sealed in PE film and not sterilized when delivered.
- > The PE film and the packaging are non-sterilizable.



- > Clean, disinfect and lubricate the medical device.
- > Sterilize the medical device, the nozzle cleaner, the bur limit stop and threaded pin.

3. Product description

Straight handpiece

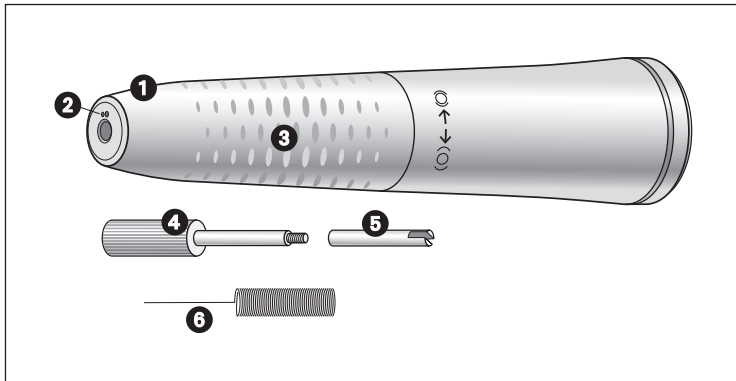

- ❶ Handpiece sleeve with twist chucking
- ❷ Spray nozzles
- ❸ Grip profile
- ❹ Threaded pin
- ❺ Bur limit stop
- ❻ Nozzle cleaner

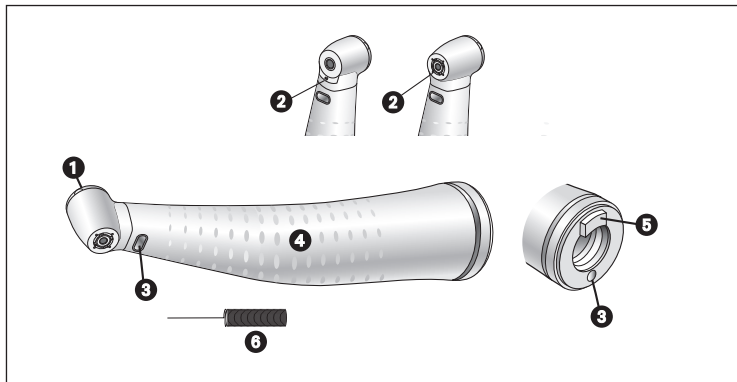

- ① Push-button
- ② Spray nozzle
- ③ Compact glass rod*
- ④ Grip profile
- ⑤ Nose*
- ⑥ Nozzle cleaner

* only contra-angles with light

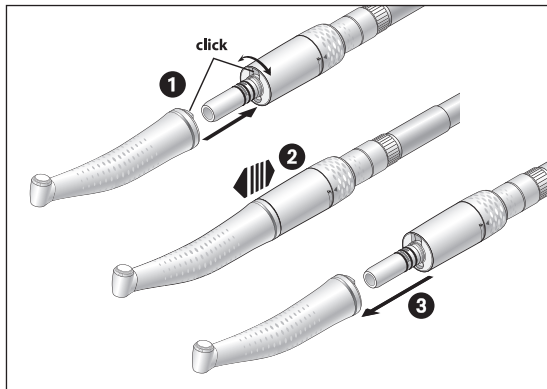

Do not assemble or remove the medical device during operation!

- 1 Push the medical device onto the motor and turn until it engages audibly.



- 2 Verify full engagement.

- 3 Remove the medical device.

Rotary instruments



- > Use only rotary instruments which are in perfect condition. Follow the operating instructions of the manufacturer.
- > Insert the rotary instrument only when the medical device is stationary.
- > Never touch the rotary instrument while it is still rotating.
- > Do not activate the chucking system of the medical device during operation. This leads to detachment of the rotary instrument, damage to the chucking system and/or heating up of the medical device. Risk of burning!

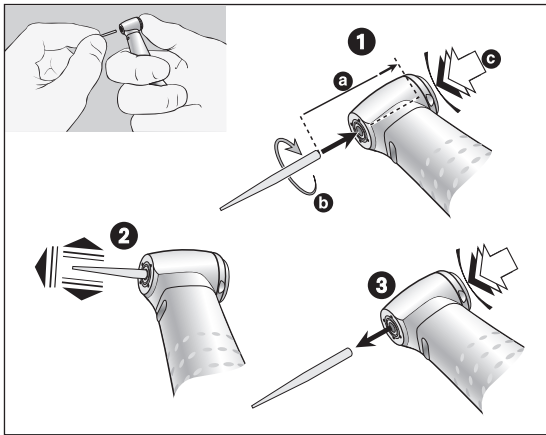

Contra-angles

To change the rotary instrument

- 1 Rotary instrument shank \varnothing 1.6 mm:
Insert rotary instrument.
Activate the button firmly (c), at the same time insert the rotary instrument until the limit stop (a).
Rotary instrument shank \varnothing 2.35 mm:
Activate the button (c), at the same time insert the rotary instrument and turn it until it engages (b).



- 2 Verify full engagement.
- 3 Remove the rotary instrument by pushing the push-button.

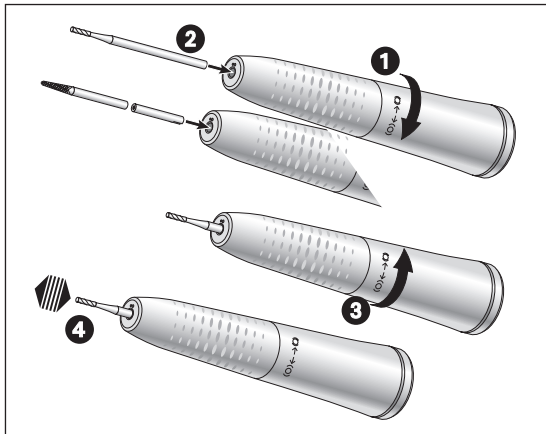

Straight handpieces

Inserting the rotary instrument

- 1** Rotate the handpiece sheath in an anticlockwise (O) ← → O direction (opening) until it clicks.
- 2** Handpiece bur:
Insert the rotary instrument up to the limit stop.
Contra-angle handpiece bur:
Insert the bur limit stop and then insert the rotary instrument up to the limit stop. The bur limit stop compensates for the difference in length.
- 3** Rotate the handpiece sheath in a clockwise (O) ← → O direction (closing) until it clicks.
- 4** Verify full engagement.



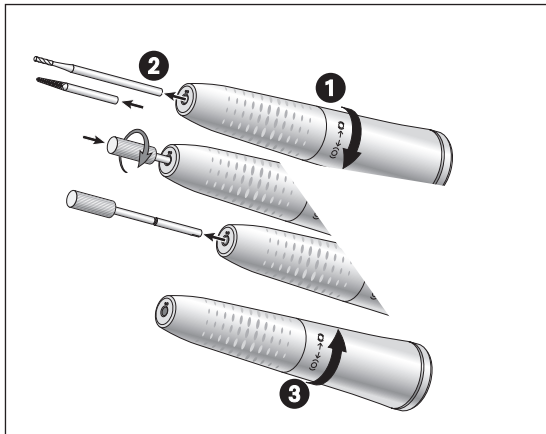

Straight handpiece Removing the rotary instrument

- 1 Rotate the handpiece sheath in an anticlockwise [0] direction [opening] until it clicks.
- 2 Handpiece bur:
Remove the rotary instrument.
Contra-angle handpiece bur:
Screw the threaded pin clockwise into the bur limit stop and pull the latter out.
- 3 Rotate the handpiece sheath in a clockwise [0] direction [closing] until it clicks.

Test run



Do not hold the medical device at eye level.

- > Insert the rotary instrument.
- > Operate the medical device.



In the event of operating malfunctions (e.g., vibrations, unusual noise, overheating, coolant failure or leakage) **stop the medical device immediately** and contact an authorized W&H service partner.



Follow your local and national laws, directives, standards and guidelines for cleaning, disinfection and sterilization.



> The information on the validated reprocessing procedures serves as an example of an ISO 17664 compliant processing of the medical device.



> Wear protective clothing, safety glasses, face mask and gloves.



> Use only oil-free, filtered compressed air with a maximum operating pressure of 3 bar (43.5 psi) for manual drying.

Cleaning agents and disinfectants



- > Read the notes, follow the instructions and heed the warnings provided by the manufacturers of cleaning agents and/or disinfectants.
- > Use only detergents which are intended for cleaning and/or disinfecting medical devices made of metal and plastic.
- > It is imperative to comply with the concentrations and exposure times specified by the manufacturer of the disinfectant.
- > Use disinfectants which have been tested and found effective by, for example: the Verbund für Angewandte Hygiene e.V. (VAH = Association for Applied Hygiene), the Österreichischen Gesellschaft für Hygiene, Mikrobiologie und Präventivmedizin (ÖGHMP = Austrian Society for Hygiene, Microbiology and Preventive Medicine), the Food and Drug Administration (FDA) or the U.S. Environmental Protection Agency (EPA).



The user is responsible for validating its process if the specified cleaning agents and disinfectants are not available.



The product lifetime and the medical device's ability to operate correctly are mainly determined by mechanical stress during use and chemical influences due to processing.

- > Send worn or damaged medical devices and/or medical devices with material changes to an authorized W&H service partner.



Processing cycles

- > We recommend a regular service for the W&H medical device after 1,000 processing cycles or one year.



Clean the medical device immediately after every treatment, to flush out liquid (e.g., blood, saliva etc.) and to prevent settling on the internal parts.

- > Operate the medical device for at least 10 seconds at idle speed.
- > Ensure that all outlets are rinsed out.



- > Wipe the entire surface of the medical device with disinfectant.
- > Remove the rotary instrument.
- > Remove the medical device.



Note that the disinfectant used during pre-treatment is only for personal protection and cannot replace the disinfection step after cleaning.



Do not place the medical device in liquid disinfectant or in an ultrasonic bath.

- > Clean the medical device under running tap water (< 35°C / < 95°F).
- > Rinse and brush off all internal and external surfaces.
- > Move moving parts back and forth several times.
- > Remove liquid residues using compressed air.

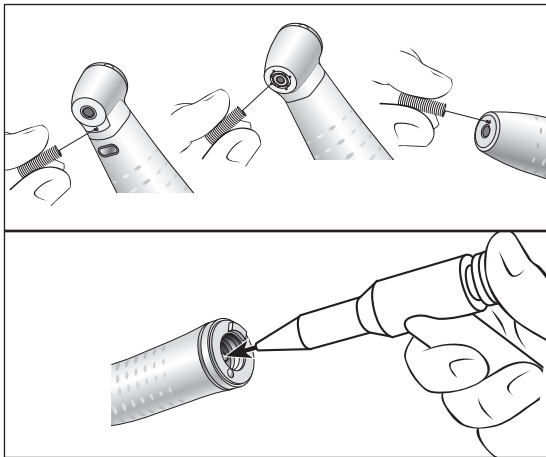

Cleaning the spray nozzles

- > Clean coolant outlets carefully with the nozzle cleaner to remove dirt and deposits.



Clean and disinfect the nozzle cleaner in an ultrasonic bath / disinfection bath.

Cleaning the coolant tube

- > Blow through the coolant tube using compressed air.



In the case of blocked coolant outlets or coolant tubes contact an authorized W&H service partner.

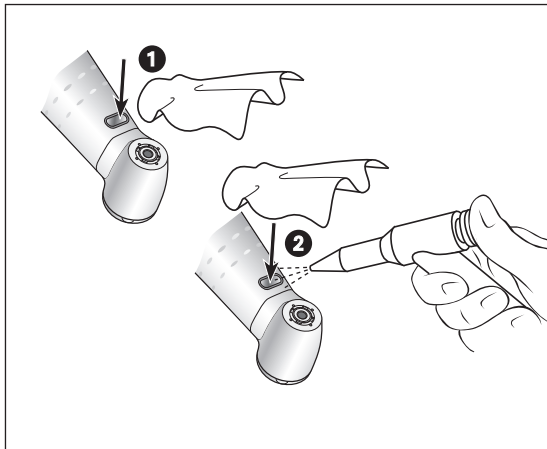

Cleaning of the light source



Avoid scratching the light source!

- 1 Wash the light source with cleaning fluid and a soft cloth.
- 2 Blow the light source dry using compressed air or dry it carefully with a soft cloth.



- > Carry out a visual inspection after each cleaning process.
- > Do not use the medical device if the light source is damaged and contact an authorized W&H service partner.



> W&H recommends wiping down with disinfectant.



Evidence of the medical device's basic suitability for effective manual disinfection was provided by an independent test laboratory using the disinfectants "mikrozid® AF wipes" (Schülke & Mayr GmbH, Norderstedt) and "CaviWipes™" (Metrex).



W&H recommends automated cleaning and disinfection using a washer-disinfector (WD).

- > Read the notes, follow the instructions and heed the warnings provided by the manufacturers of washer-disinfectors, cleaning agents and/or disinfectants.



Evidence of the medical device's basic suitability for effective automated disinfection was provided by an independent test laboratory using the "Miele PG 8582 CD" washer-disinfector (Miele & Cie. KG, Gütersloh) and the "Dr. Weigert neodisher® MediClean forte" cleaning agent (Dr. Weigert GmbH & Co. KG, Hamburg) according to ISO 15883.

- > Cleaning at 55°C (131°F) – 5 minutes
- > Disinfection at 93°C (200°F) – 5 minutes



- > Ensure that the medical device is completely dry internally and externally after cleaning and disinfection.
- > Remove liquid residues using compressed air.

Inspection



- > Check the medical device after cleaning and disinfection for damage, visible residual soiling and surface changes.
- > Reprocess any medical devices that are still soiled.
- > Sterilize the medical device following cleaning, disinfection and lubrication.

Lubrication



> Lubricate the dry medical device immediately after cleaning and/or disinfection.

Recommended lubrication cycles

- > Essential after every internal cleaning
- > Before each sterilization

or

- > After 30 minutes of use or once a day
- > chucking system once a week

With W&H Service Oil F1, MD-400

- > Follow the instructions on the oil spray can and on the packaging.

or

With W&H Assistina

- > Follow the instructions in the Assistina Instructions for use.

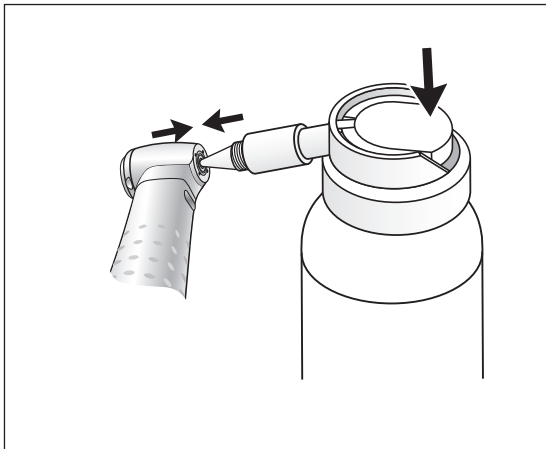

**Lubrication of the chucking system
WG-900 LT/A, WG-99 LT/A, WG-57 LT**

With W&H Service Oil F1, MD-400

- > Fit the spray cap REF 02036100 onto the oil spray can.
- > Hold the medical device firmly.
- > Press the tip of the spray nozzle firmly into the chucking system.
- > Spray for approximately 1 second.

or

With W&H Assistina

- > Follow the instructions in the Assistina Instructions for use.

Test after lubrication



- > Direct the medical device downwards.
- > Operate the medical device so that excess oil can escape.
- > Excess oil may result in the medical device overheating.



Pack the medical device and the accessories in sterilization packages that meet the following requirements:

- > The sterilization package must meet the applicable standards in respect of quality and use and must be suitable for the sterilization method.
- > The sterilization package must be large enough for the sterilization goods.
- > The filled sterilization package must not be under tension.



W&H recommends sterilization according to EN 13060, EN 285 or ANSI/AAMI ST55.



- > Read the notes, follow the instructions and heed the warnings provided by the manufacturers of steam sterilizers.
- > The program selected must be suitable for the medical device.

Recommended sterilization procedures

- > “Dynamic-air-removal prevacuum cycle” (type B) / “Steam-flush pressure-pulse cycle” (type S)*/**
134°C (273°F) for at least 3 minutes, 132°C (270°F) for at least 4 minutes
- > “Gravity-displacement cycle” (type N)**
121°C (250°F) for at least 30 minutes
- > Maximum sterilization temperature 135°C (275°F)



Evidence of the medical device's basic suitability for effective sterilization was provided by an independent test laboratory using the LISA 517 B17L* steam sterilizer (W&H Sterilization S.r.l., Brusaporto (BG)), the Systec VE-150* steam sterilizer (Systec) and the CertoClav MultiControl MC2-S09S273** steam sterilizer (CertoClav GmbH, Traun).

“Dynamic-air-removal prevacuum cycle” (type B): 134°C (273°F) – 3 minutes*, 132°C (270 °F) – 4 minutes*/**
“Steam-flush pressure-pulse cycle” (type S): 134°C (273°F) – 3 minutes*, 132°C (270 °F) – 4 minutes*/**
“Gravity-displacement cycle” (type N): 121°C (250°F) – 30 minutes**

Drying times:

“Dynamic-air-removal prevacuum cycle” (type B): 132°C (270°F) – 30 minutes**
“Steam-flush pressure-pulse cycle” (type S): 132°C (270°F) – 30 minutes**
“Gravity-displacement cycle” (type N): 121°C (250°F) – 30 minutes**

* EN 13060, EN 285, ISO 17665

** ANSI/AAMI ST55 , ANSI/AAMI ST79



- > Store sterile goods dust-free and dry.
- > The shelf life of the sterile goods depends on the storage conditions and type of packaging.

6. Servicing

Repairs and returns

In the event of operating malfunctions immediately contact an authorized W&H service partner.

Repairs and maintenance work must only be undertaken by an authorized W&H service partner.



> Ensure that the medical device has been completely processed before returning it.

7. Accessories, consumables, spare parts and other recommended medical devices by W&H



Use only original W&H accessories and spare parts or accessories approved by W&H.

Suppliers: W&H partners

000301xx	W&H Assistina
30310000	Assistina TWIN (MB-302)
02693000	Assistina adaptor for chucking system
10940021	W&H Service Oil F1, MD-400 (6 pcs)
02015101	Nozzle cleaner
02038200	Spray adaptor for straight/contra-angle handpieces
02036100	Spray adaptor for chucking system
01312500	Bur limit stop
01312600	Threaded pin (for dismantling bur limit stop)

8. Technical data

Straight handpiece		HG-43 A	
Transmission ratio		1 : 1	
Colour coding		blue	
Motor coupling	acc. to	ISO 3964	
Instrument shaft diameter	ISO 1797 [mm]	2.35	
Length in mm approved by W&H*	[mm]	Contra-angle bur 34	Handpiece bur 50
Chucking*		Contra-angle shank: with bur limit stop	Handpiece shank
Min. chucking length*		until back stop	until back stop
Max. motor speed	[min ⁻¹]	40,000	
Spray flow rate	ISO 14457 [ml/min]	> 50	
Water setting range [rec. water pressure] **	[bar]	0.5 – 2 (1.5)	
Chip air setting range [rec. chip air pressure] **	[bar]	1.5 – 3 (2)	
Chip air consumption at 2 bar	[l/min]	> 1.5	

* see page 43

Technical data

Contra-angle handpieces	WG-900 LT/A	WG-99 LT/A	WG-57 LT	WG-56 LT/A	WG-66 LT/A
Transmission ratio	1:4	1:5	1:1	1:1	2:1
Colour coding	red	orange	blue	blue	green
Motor coupling acc. to	ISO 3964	ISO 3964	ISO 3964	ISO 3964	ISO 3964
Instrument shaft diameter ISO 1797 [mm]	1.6	1.6	1.6	2.35	2.35
Length in mm approved by W&H * [mm]	25	25	25	34	34
Min. chucking length	until back stop	until back stop	until back stop	engaging	engaging
Max. operating part diameter [mm]	2.5	2.5	2.5	–	–
Max. motor speed [min ⁻¹]	40,000	40,000	40,000	40,000	40,000
Spray flow rate ISO 14457 [ml/min]	> 50	> 50	> 50	> 50	> 50
Water setting range [rec. water pressure] ** [bar]	0.5 – 2 (1.5)	0.5 – 2 (1.5)	0.5 – 2 (1.5)	0.5 – 2 (1.5)	0,5 – 2 (1,5)
Chip air setting range [rec. chip air pressure] ** [bar]	1.5 – 3 (2)	1.5 – 3 (2)	1.5 – 3 (2)	1.5 – 3 (2)	1.5 – 3 (2)
Chip air consumption at 2 bar [Nl/min]	> 1.5	> 1.5	> 1.5	> 1.5	> 1.5

* see page 43



* When using longer rotary instruments the user must ensure by correct selection of the operating conditions, that there is no danger to the user, patient or third parties.
For safe use, follow the respective manufacturer's instructions regarding maximum speed of the rotating instrument.

** The chip air / water pressure must be set at the same time
The chip air must be higher than the water pressure

min^{-1} (Revolutions per minute)



Temperature information

Temperature of the medical device on the operator side: maximum 55°C (131°F)

Temperature of the medical device on the patient side: maximum 50°C (122°F)

Temperature of the working part (rotary instrument): maximum 41°C (105.8°F)

Ambient conditions

Temperature during storage and transport:

-40°C to +70°C (-40°F to +158°F)

Humidity during storage and transport:

8% to 80% (relative), non-condensing

Temperature during operation:

+10°C to +35°C (+50°F to +95°F)

Humidity during operation:

15% to 80% (relative), non-condensing

9. Disposal



Ensure that the parts are not contaminated on disposal.



Follow your local and national laws, directives, standards and guidelines for disposal.

- > Medical device
- > Packaging

Explanation of warranty terms

This W&H medical device has been manufactured with great care by highly qualified specialists. A wide variety of tests and controls guarantees faultless operation. Please note that claims under warranty can only be validated when all the directions in the instructions for use have been followed.

As the manufacturer, W&H is liable for material or manufacturing defects within a warranty period of 24 months from the date of purchase. Accessories and consumables (nozzle cleaner, threaded pin, bur limit stop) are excluded from the warranty.

We accept no responsibility for damage caused by incorrect handling or by repairs carried out by third parties not authorized to do so by W&H!

Claims under warranty accompanied by proof of purchase, must be sent to the vendor or to an authorized W&H service partner. The provision of service under warranty extends neither the warranty period nor any other guarantee period.

24 months warranty

Authorized W&H service partners

Find your nearest authorized W&H service partner at <http://wh.com>
Simply go to the menu option “Service” for full details.

Or simply scan the QR code.





W&H Dentalwerk Bürmoos GmbH

Ignaz-Glaser-Straße 53, 5111 Bürmoos, Austria

**t + 43 6274 6236-0,
office@wh.com**

**f + 43 6274 6236-55
wh.com**

**Form-Nr. 50744 AEN
Rev. 006 / 20.06.2023
Subject to alterations**