

Instructions for Use



seethrough^{FLEX}

XRE-200

XRE-200 - ENG - Rev02

Table of contents

Conformity	4	Maintenance	75
Symbols and messages	6	Cautions for maintenance operations	75
Introduction	11	Ordinary maintenance	75
About this manual	11	User maintenance	76
Use restrictions	12	Disposal	80
Abbreviation used in this manual	15	Diagnostics	81
Safety information	16	Messages	82
Safety Warnings	16	Technical data	85
Cyber security	18	List of available exams	86
Responsibility	23	Technical data	103
Connection to an IT-network	23	Dosimetry	108
Getting started	24	Components, spare parts, consumables	134
Requirements	24	Authorized W&H service partners	136
Product description	27		
Operating the unit	43		
seethrough studio	43		
Operation	44		
Exam preparation	45		
Preparing the device	55		
Patient positioning	56		
X-ray exposure	63		
Exam evaluation	73		
Power the unit OFF	74		

Conformity

The seethrough^{FLEX} device conforms with the following Regulations, Directives and Standards:

CONFORMITY TO EUROPEAN AND AMERICAN REGULATIONS, STANDARDS AND DIRECTIVES

Risk management

ISO 14971	Application of risk management to medical devices
-----------	---

Safety

IEC 60601-1	General requirements for basic safety and essential performance for medical electrical equipment
IEC 60601-1-2	Requirements and tests for electromagnetic disturbances
IEC 60601-1-3	Radiation protection in diagnostic X-ray equipment
IEC 60601-2-63	Particular requirements for the basic safety and essential performance of dental extra-oral X-ray equipment
ISO 10993-1	Biological evaluation of medical devices: evaluation and testing within a risk management process
Directive 2013/59/EURATOM	Basic safety standards for protection against the dangers arising from exposure to ionising radiation

CONFORMITY TO REGULATIONS, STANDARDS AND DIRECTIVES ONLY FOR CE MARKET

Regulations for medical devices

	Medical Device Regulation (MDR).
	Regulation (UE) n. 2017/745 for medical devices. Class IIb devices, in accordance with the Rule 10 – ANNEX VIII of the above Regulation.

Note: Every new seethrough^{FLEX} device is delivered with a Declaration of Conformity and a Warranty Card.

CLASSIFICATION IN ACCORDANCE WITH IEC 60601-1

Equipment class	IP20
Type of protection against electric shock	Class 1 equipment
Degree of protection against electric shock Applied part	Type B 
Operation mode	Continuous operation with intermittent loading
Flammable anesthetics	Not suitable for use in presence of flammable anesthetics or a mixture of flammable anesthetics with air or oxygen or nitrous oxide
List of applied parts	<ul style="list-style-type: none"> ■ Temple supports ■ Bitewing ■ Edentulous/TMJ support ■ Chinrest ■ Patient handle

ELECTROMAGNETIC COMPATIBILITY (EMC)

The seethrough^{FLEX} device conforms with IEC 60601-1-2 standard.

The device is suitable for the use in home healthcare facilities environments.



CAUTION:

- The device shall be used in an environment compliant to the standard. Otherwise, the user can expect a misbehavior of the device or the production of images not suitable for diagnosis.
- Use of this equipment adjacent to or stacked with other equipment should be avoided because it could result in improper operation. If such use is necessary, this equipment and the other equipment should be observed to verify that they are operating normally.
- Use of components, transducers and cables other than those specified or provided by the manufacturer of this equipment could result in increased electromagnetic emissions or decreased electromagnetic immunity of this equipment and result in improper operation.
- Portable RF communications equipment (including peripherals such as antenna cables and external antennas) should be used no closer than 30 cm (12 inches) to any part of the seethrough^{FLEX}, including cables specified by the manufacturer. Otherwise, degradation of the performance of this equipment could result.

List of replaceable cables

Cable	Length (m)
Detector Ethernet cable	10
Workstation Ethernet cable	10
Coil cord extension lead	10
Door safety cable (optional)	10
System ON white lamp cable (optional)	10
X-ray emission red lamp cable (optional)	10



CAUTION: To guarantee the performance of the seethrough^{FLEX}, maintenance instructions explained in the "Repair & Spare parts" guide shall be followed.

Symbols and messages

SAFETY SYMBOLS USED IN THIS MANUAL



CAUTION: Indicates a hazardous situation that, if not avoided, could result in minor or moderate injury.



Risk of crushing of hands.

PROPERTY DAMAGE MESSAGES







Notice: Indicates information considered important, but not hazard-related. Typically to avoid damage to the product.









LEDS









LEDs indicate the machine status. The user shall be aware that when LEDs are not green, the machine is not ready to perform any exams (see "Capacitive keyboard LEDs " on page 32)







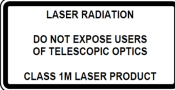

SYMBOLS ON LABELS (DEVICE AND SHIPPING BOX)



The following symbols are reported on external labels and on the shipping box of the device. To check the position of labels, see "Labels on the unit" on page 9.

	Medical Device
	seethrough FLEX device type or model
	Catalogue number
	Serial Number
	Part Number
	Unique Device Identification
	Health industry bar code in accordance with HIBC Standard

	GS1 datamatrix for logistic purpose
	Country of manufacture, followed by manufacturing date (YYYY-MM-DD)
	CE mark
	Manufacturer
	This side up
	Fragile, handle with care
	Keep dry
	The seethrough FLEX device must be transported by two authorized technicians due to its heavy weight
	Temperature (between XX °C and XX °C - values reported on the symbol)

	Humidity (between XX % and XX % - values reported on the symbol)
	Atmospheric pressure limitation (between XX hPa and XX hPa - values reported on the symbol)
	Storage
	Transportation
	Packaging unit (1/2, 2/2)
	Caution: danger
	Caution: ionizing radiation
	Caution: laser beam
	Class 1M laser

	Consult instructions for use
	Consult electronic instructions for use
	Obligation to read the Instructions for Use before operating the device
	Waste for electrical and electronic equipment
	X-ray source assembly
	X-ray tube
	Inherent radiation filtration
	Total radiation filtration
	Intermediate focal spot

	Large focal spot
V	Nominal voltage
Hz	Frequency range
A	Absorbed current
kVA	Power
	Class I appliance class - protective earth
	Type B applied part
IP	Equipment class

LABELS ON THE UNIT

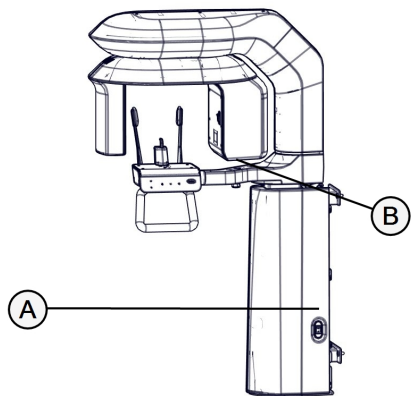



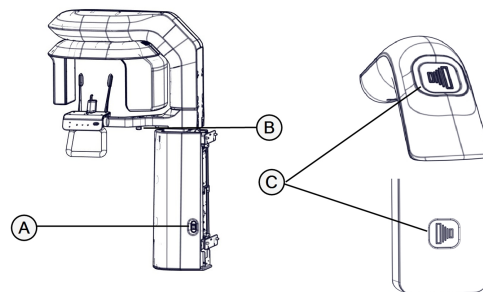

Label	Position
seethrough ^{FLEX} label	A
X-ray tube and laser label	B

IDENTIFICATION TAGS ON THE DEVICE



Symbol	Description	Position
	ON (supply) IEC 60417-5007	A
○	OFF (supply) IEC 60417-5008	

Symbol	Description	Position
	Emergency Stop Command (IEC 60417 Ref. 5638)	B
	Caution: risk of crushing hands	
	Type B applied part	
	X-ray command (IEC 60417)	C

Introduction

CONTENTS

This section deals with the following subjects:

About this manual	11
Use restrictions	12
Abbreviation used in this manual	15

About this manual

INTRODUCTION

This manual contains the Instructions for Use of the W&H seethrough^{FLEX}.

FOR YOUR SAFETY AND THE SAFETY OF YOUR PATIENTS

The purpose of this manual is to provide information about seethrough^{FLEX} to ensure:

- optimal use;
- safe and reliable operation;
- compliance with regular maintenance and servicing requirements.

Please read carefully the safety information (see "Safety Warnings" on page 16).

It is recommended to keep a copy of this manual nearby as a reference guide during the use of the device.

OBLIGATIONS WITH REGARD TO THIS MANUAL

This manual is an integral part of the product and accompanies it for its entire working life. It must be consulted in all situations related to the life cycle of the product, from its delivery through to decommissioning. For this reason, it should always be accessible to operators both online and offline.

Contact customer service in the event the manual is unavailable. If the device is transferred, always attach the manual for the new owner.

MANUAL CONTENT

This manual contains the Instructions for Use and for maintenance of the following device :

- seethrough^{FLEX}, XRE-200

Two variants of the device are available:

- equipped with a capacitive keyboard
- equipped with a touchscreen

The device consists of the acquisition unit seethrough^{FLEX} and the software used for analysis and elaboration of images (DID-200 seethrough studio).

For an easier configuration, the manufacturer provides the seethrough^{FLEX} together with a PC with the seethrough studio software already installed. Refer to the seethrough studioInstructions for Use.

INSTRUCTIONS FOR USE

The complete manual (Instructions for Use) is available at the www.wh.com website. See back cover of this manual.

SERVICE LITERATURE

Technical information related to:

- Installation
- Product description
- Repair and Spare Parts
- Test Instructions
- Errors and Troubleshooting

are available in the Service literature. Only trained technician can access the Service literature. Contact the manufacturer for further information.

DISCLAIMER

All pictures, graphics and illustrations provided in this manual are for the comprehension of the text. They are not meant to be an accurate representation of product details. Thus, they should be taken as indicative only, and may differ from the actual product.

For any suggestions or remarks please send an email to office.sterilization@wh.com.

For any suggestions or remarks please contact W&H or an authorized service partner.

COPYRIGHT NOTICE

Copyright ©, W&H Sterilization Srl

All rights reserved in all countries.

All drawings, images and texts contained in this manual are the property of the manufacturer. Even partial duplication of drawings, images or text is prohibited.

The information contained in this document is subject to change without prior notice.

Use restrictions

INTENDED USE

The seethrough^{FLEX} device is a dental X-ray device with an extraoral source intended to perform 2D, 3D, panoramic and tomographic exams through the generation of digital diagnostic images of:

- dento-maxillo-facial region;
- cervical spine region;
- ENT (Ear, Nose and Throat) region;

at the direction of dental healthcare professionals.

TARGET USERS

seethrough^{FLEX} is intended to be used by dentists, radiologists and any other legally qualified health care professionals with suitable experience in radiation protection or knowledge of radiation protection, trained in the operation of X-ray equipment.

TARGET PATIENTS

The device is intended to be used on patients. For the intended purpose of this device, seethrough^{FLEX} can be used on:

- children,
- adults,
- adult patients in wheelchairs.

LIMITATIONS

Since the device emits ionizing radiations, the use on patients should be carried out only when the healthcare professional deems the diagnostic benefits associated with the use of the device to be superior to the potential risks associated with radiation exposure of the patient.



CAUTION: The device offers radiological exams specifically designed for the pediatric population. These exams are characterized by lower radiation doses compared to standard protocols. However, the decision to perform the exams and select the appropriate program must always be evaluated by the competent physician, taking into account the specific risk-benefit for each patient.



CAUTION: Before performing an X-ray exams, medical professionals must confirm whether women of reproductive age are currently pregnant, could potentially be pregnant, or are breastfeeding. In such cases, it is the responsibility of the physician to carefully assess the risks and benefits of proceeding with the X-ray exams. The decision should take into account the patient's condition and the potential impact of radiation exposure.

Radiation protection cautions

Radiation protection regulations shall be observed while using the system. Respect the national guidelines when exposing patients, especially with pediatrics patients.

The place where the device is installed shall be compliant with the regulations for protecting against radiation.

The use of equipment, such as lead shields or aprons, are strictly recommended, especially with pediatric patients.

In Europe, the Directive 2013/59/Euratom represents the most recent regulatory framework of radiation protection which is of high relevance across all European countries, and therefore, medical/dental professionals prescribing X-ray images are urged to follow its recommendations.

If not strictly necessary, avoid the exposure of pregnant and/or breastfeeding to radiation.

During the exposure, the operator shall move as far away as the X-ray button cable/the remote controller connectivity permits. It is recommended for the operator to protect themselves behind radiation shielding screenings. The operator shall not lose the visual contact with the patient during the exam.

No third person are allowed to stay in the room during the exposure.



CAUTION: In case of malfunctioning, release immediately the X-ray exposure button.

INDICATIONS AND CONTRAINDICATIONS

Indications

seethrough^{FLEX} can be used in the following fields:

- Endodontics.
- Periodontology.
- Dental prosthesis.
- Functional diagnosis and therapy of craniomandibular dysfunctions.
- Dental surgery.
- Dental implants.
- Oral and Maxillofacial surgery.
- Orthodontics.
- Otorhinolaryngologist - ENT (middle and inner ear, paranasal sinuses, main nasal cavity, maxillary sinus, ethmoidal cells, sphenoidal sinus, frontal base of the skull, frontal sinus).

Known contraindications

Compared with a Medical Computed Tomography Scanner, in CBCT there is lower contrast resolution, which means less discrimination between different tissue types (*i.e.*, bone, teeth, and soft tissue)

Selection criteria for the use of radiology in dental implantology with emphasis on CBCT:

- CBCT should not be used as an initial diagnostic imaging examination
- CBCT should be avoided to obtain data that can be provided by alternate nonionizing modalities (*i.e.*, to produce virtual orthodontic study models)
- CBCT should not be used for the periodic review of clinically asymptomatic implants

Abbreviation used in this manual

2D	Two-dimensional
3D	Three-dimensional
CBCT	Cone-Beam Computed Tomography
IB	Interface board
MB	Master board
NIC	Network Interface Card
PANO	Panoramic exam
PMS	Practice Management System
ROI	Region Of Interest
SB	Slave board
TMJ	Temporomandibular junction

Safety information

CONTENTS

This section deals with the following subjects:

Safety Warnings	16
Cyber security	18
Responsibility	23
Connection to an IT-network	23

Safety Warnings

Follow these safeguards and properly use the equipment to prevent injury and damage to any equipment/data.

ELECTRICAL RISKS



- To avoid the risk of electric shock, this equipment must only be connected to a supply mains with protective earth.
- The machine is installed with a dedicated circuit.
- Do not pour water or any other liquids over the seethrough^{FLEX} device (risk of electrical short circuits).
- The use of any type of liquids is forbidden near the seethrough^{FLEX} device.
- Before inspecting, carrying out maintenance or servicing the seethrough^{FLEX} device, switch off the device and wait 3 minutes.
- Switch off the device and open the thermal-magnetic residual-current circuit breaker before inspecting, carrying out maintenance or servicing the seethrough^{FLEX} device.

EMERGENCY STOP



- If any parts of the unit touch the patient during the exposure, immediately release the X-ray button or stop the unit by actuating the emergency stop button.
- In case of any emergency, activate the emergency stop button (located under the patient support arm, see "General view" on page 27).

ENVIRONMENTAL CONDITIONS



- To avoid damages to the device and to people in contact with the device, do not exceed the maximum environmental temperature as specified in this manual (see "Environmental requirements" on page 106).

LASER USE



- Use of controls or adjustments or performance of procedures other than those specified herein may result in hazardous radiation exposure".

IMPROPER USE OF THE SEETHROUGH^{FLEX} DEVICE



- The use of the seethrough^{FLEX} device is limited to professional users. The use from not qualified personnel can lead to patient overexposure.
- The seethrough^{FLEX} shall be used only in a controlled environment

TAMPERING



- Do not remove the name plate or labels from the seethrough^{FLEX} device
- Repairs, maintenance or service must be carried out by authorized service providers always using genuine spare parts

REQUIREMENTS



- Use only components authorized by the manufacturer
- In case of malfunction of the seethrough^{FLEX} device, contact an authorized technician or the manufacturer

AFTER TRANSPORT



During unit transport and other installation maneuvers, dirt on the X-ray detector can lead to image artifacts and consequent patient overexposure due to exam repetition

- Before using the unit, make sure that the installation was controlled by a qualified technician

IN CASE OF INCIDENT



- Serious incidents that have occurred in relation to this medical device should be reported to the manufacturer and competent authority in the country where the incident occurred

Cyber security

Cybersecurity has been implemented according to the “MDCG 2019-16 - Guidance on Cybersecurity for medical devices”.

Cyber security is the process of preventing unauthorized access, modification, misuse, denial of use or the unauthorized use of information that is stored, accessed or transferred from a medical device to an external recipient. A local administrator, or service provider, is a user who is authorized by the owner to perform

security relevant functions that ordinary users are not authorized to perform.

Cyber security risk management is a shared responsibility among stakeholders including W&H, the user, and the healthcare facility. Failure to maintain cyber security can result in compromised device functionality, loss of data availability, loss of data integrity or expose other connected devices or networks to security threats. These threats can be:

- re-purposing of the system computing capability if a malware can access the operating system;
- re-purposing of the system computing capability if operators can access the operating system;
- exposition to unauthorized use or alteration of the device by malware;
- exposition to unauthorized use or alteration by unauthorized access.

A cyber security event can be detected in several ways:

- operation and/or network connection slower than normal;
- suspicious pop-ups or home page changes in internet browser;
- no passwords working at a certain point;
- unidentified programs in start menu or system tray;
- missing, corrupted or altered data.

W&H seeks to protect the security of your data while also providing measures to strengthen the resiliency of the products from external cyber security attackers. W&H complies with applicable security and privacy regulations.

W&H communications policy strives for coordinated disclosure. W&H works in this way with our customers and other parties, when appropriate, in response to potential vulnerabilities and incidents involving our medical devices, no matter the source.

W&H maintains a set of cyber security controls to assure the cyber security of its units and to maintain their functionality and safety.

DEVICE CONNECTIVITY

The following interfaces are critical for cyber security:

- LAN port for interoperability with:
 - clinical server;
 - DICOM modality worklist;
 - W&H Remote Service [ioDent];
 - DICOM/PACS for image storage;
 - connection to acquisition devices;
- USB ports of the PC, for connection to various USB-storage devices.

RECOMMENDATION FOR CYBERSECURITY

W&H recommends always to follow network security best practices, such as maintaining software, segmenting via firewalls, closing unused ports, restricting user permissions, limiting third party access and monitoring network activity. This device is designed to be used either as a standalone unit or connected to the facility's internal PACS or other closed-loop networks. It is not intended to be connected to the Internet, unless:

- the facility is specifically instructed to do so by W&H;
- the facility takes adequate precautions to ensure the cyber security of the unit from threats related to its Internet connection.

In addition, seethrough studio software is password protected; therefore, only authorized users can access to the software and its data, while other users can get to the operating system without being able to access the software.

W&H will develop updates or patches for the seethrough studio software, in order to continuously ensure the product safety, as needed throughout the life-cycle of the unit.

CLINICAL SERVER DATA STORAGE

The clinical server stores clinical image files in the OS filesystem, in order to optimize and simplify data backups. This requires careful selection of the storage location as recommended in this IFU, in the following chapters. Clinical server keeps other patient data (personal identification) in a database, not accessible directly by users.

CLOUD SECURE COMMUNICATION

A secure communication (with authentication and authorization) can be established between the application and the cloud server for the following functionalities:

- remote software update;
- setting management;
- device monitoring;
- clinical image sharing.

The user and authorized technicians can interact with the cloud server by means of a generic device (e.g.: PC, tablet, smartphone) with a web browser and proper authorization and authentication.

INFRASTRUCTURE REQUIREMENTS

In order to minimize the possibility of cyberattacks, it is user responsibility to apply the following measures:

- software update/install shall be done by authorized and trained personnel only;

- it is recommended to activate a firewall on the router/modem used for the Internet connection.

In addition, the definition and maintenance of the local IT network configuration, including firewall rules, routing policies, VLAN segmentation, Group Policy Objects (GPOs), access control lists, and any network-level authorization or blocking mechanisms, are under the full responsibility of the customer or the healthcare facility's IT administrator.

W&H provides the necessary technical information for interoperability but does not manage or validate customer network configurations. The customer must ensure that such configurations are compliant with applicable cybersecurity standards and do not interfere with the intended use of the medical device.

Note: further security information is mentioned in the MDS2 document, which is available on request.

SOFTWARE BILL OF MATERIAL (SBOM)

The device provides the possibility to access the SBOM.

EVENTS POSSIBLY CAUSED BY A CYBERATTACK DETECTABLE BY THE USER

The following situations, visible by the user, could be caused by cybersecurity events:

- frozen screen;
- corrupted or inaccessible clinical image files;
- significant slowdown when navigating the menus;
- malfunctioning or blocked network services (such as: remote data storage and access, cloud server access, etc.).

EVENTS POSSIBLY CAUSED BY A CYBERATTACK DETECTABLE BY THE USER

If a cybersecurity event or incident occurred, or in case of a suspect, the following indication shall be followed to minimize the impact and prevent further damage:

- disconnect the customer server and the customer PC from the network (Ethernet cable and/or WiFi dongle) to prevent spreading the damage to other devices and protect the stored data;
- disconnect the USB storage media to reduce the possibility to corrupt stored data;
- inform the IT department and an authorized technician (or device manufacturer) and follow the indications they would provide to secure the affected device.

USER RESPONSIBILITIES

Authentication of OS users

The operating system itself allows the end user to establish and configure "User Accounts". The authentication shall be performed with a password and/or with more secure approaches e.g. 2FA (two factor authentication).

In order to minimize the possibility of cyber-attacks, the following protection measures are strongly recommended:

- protect with personal password every user account on the Windows login. Passwords shall be:
 - strong (made at least of 8 alphanumeric characters),
 - safely managed by every user,
 - periodically changed.

Authentication of Application users

The seethrough^{STUDIO} system allows the end user to establish and configure “Application User Accounts”. The authentication shall be performed with a password.

In order to minimize the possibility of cyber-attacks, the following protection measures are strongly recommended:

- Passwords shall be:
 - strong (made at least of 8 alphanumeric characters),
 - safely managed by every user,
 - periodically changed.

Auto-logout/Screen Lock

The operating system can prevent access and misuse by unauthorized users if the device is left idle for a period of time. The following precautions are recommended:

- the length of inactivity time before auto-logout/screen lock is customizable by the user/administrator,
- the auto-logout/screen lock should be always enabled,
- the local supervisor should prevent unauthorized user from accessing the dedicate laptop or PC, in order to preserve system and data confidentiality, integrity and availability,
- the local supervisor must set the logon screen saver timeout time to reduce accidental view of data.

Malware, virus, and network threat protection

Due to the risk of viruses and other malware, users are required to install and configure appropriate antivirus software (such as Windows Defender or XProtect) to protect their device. Please ensure that your system is properly secured before use.

It is recommended also to:

- make sure that all the other PCs in the network are protected by an anti-virus,
- implement policies for periodic scan of the entire system and third party software updates by the local administrator,
- keep the OS up to date by installing all the security patches;
- activate the OS firewall on the customer PC and customer server,
- activate a firewall on the WAN router/modem used for internet connection, if present,
- avoid installation of any unknown or untrusted software since it may undermine performance and safety of the PC and the equipment.

Application installation and updates

In order to avoid unintended installation of malicious software, all application installers are signed by the manufacturer. It is required for users and technicians to verify the signature of the installers upon new installations or upgrades. Users and technicians shall not proceed with installation if the signature is not verified.

As periodic updates for seethrough studio software become available, the local administrator should evaluate these against the site needs and determine whether the update is suitable and/or applicable to their usage. The local administrator should only use updates/installation materials from the manufacturer as provided by the manufacturer or a representative service provider.

Data storage configuration

The clinical server application requires the selection of the clinical image file path upon installation. The path must be selected by users and technicians, considering the strictest safety and security approaches in cooperation with the local IT and network system

administrator. The customer server PC and the PC containing the clinical image path shall be installed in a secure location, not accessible by unintended users, as disassembling the customer server PC or the PC containing the clinical image path might result in confidential data exposure.

Data backup

To avoid the loss of patient data due to damage to the storage device of the user's PC, it is recommended to regularly backup the data.

The application provides features to create snapshots of data. This feature is compatible with an intense and continuous use of the application and does not require the normal operations to be paused or stopped. This data snapshot is not to be considered as a long term backup solution; it is under the responsibility of the users to keep this data snapshots copied in a secure location, for long term backup.

To this end, it is recommended to:

- store the data in multiple different and independent storage media to disperse the risk of data loss or damage to the storage device,
- make regular copies (backup) of all your valuable data and store them in a safe place, separately from the host PC,
- make a virus scan of USB sticks or CD/DVD media before using them to check they are free from viruses, malware or any dangerous software.

W&H RECOMMENDATIONS

Elements of our product and solution security program are included in this list:

- the initial software installation and system setup shall be done by authorized and trained personnel only and using the software provided with the machine,
- any software or firmware upgrade of the seethrough^{FLEX} device should be done by authorized and trained personnel only,
- after any software or firmware upgrade or any other maintenance operation, image quality checks shall be performed to ensure the system is working as expected,
- W&H provide information in the Instructions for Use to facilitate secure configuration and use of our medical devices in your IT environment.

seethrough^{FLEX} device settings may be compromised in the event of a cyber security attack or other configuration error. To restore device settings to their previous state, power cycle the unit and select NO when prompted on the New Patient screen. Device settings can be restored manually with patient discharge and re-admit at the seethrough^{FLEX} device. In the event of a cyber security attack, if the device enters a fail state (sustained alarm tone sound), power cycle the unit. If a device experiences multiple resets and/or fail state behavior, assign each patient to a bedside monitor, isolate the affected devices and immediately contact your hospital's biomedical department and IT department for support. Do not place devices back into service until the situation is solved.

Responsibility

USER RESPONSIBILITY

- The user is responsible for the correct use and maintenance of the device in accordance with these Instructions for Use.
- The safety devices of the seethrough^{FLEX} device are impaired when the product itself is not used and serviced in accordance with these Instructions for Use.
- The Instructions for Use updated to the latest version is always available at www.wh.com
- Keep these Instructions for Use for future reference.

MANUFACTURER RESPONSIBILITY

- The manufacturer can only accept responsibility for the proper installation, safety, reliability and performance of the product when the product itself is installed, used and serviced in accordance with the Instructions for Use.
- Servicing by unauthorized persons invalidates all claims under warranty and any other claims.

Connection to an IT-network



CAUTION: When connecting the seethrough^{FLEX} to an IT-Network, always respect cyber security recommendations reported in "Cyber security" on page 18.

The seethrough^{FLEX} can be connected to an IT-Network with the scope of transferring or storing data. USB storage devices and the

PACS/DICOM network (www.dicomstandard.org) can be used for this aim. The person in charge of IT security in the dental practice is responsible for providing methods for preventing cyber attacks, such as the use and the update of an anti-virus, the use of a firewall and the access protection. For the list of recommended measures to implement, see "Cyber security" on page 18.

In order to guarantee a proper data storage to ensure their availability, it is recommended to save them periodically to an external storage.

Getting started

CONTENTS

This section deals with the following subjects:

Requirements	24
Product description	27
Operating the unit	43
seethrough studio	43

Requirements

Notice: the installation procedure is detailed into the Service Literature (Installation book). Refer to the manufacturer for the installation.

ROOM REQUIREMENTS



CAUTION: The seethrough^{FLEX} device shall be positioned in the room to ease the disconnection in case of necessity. Avoid any collisions with room objects during the exams (or when the device is moving). Installation is performed by trained technician taking into account the room configuration for guaranteeing safety: do not change the seethrough^{FLEX} device position after the installation.



CAUTION: Verify that there are no external voltage sources that could come into contact with the device.

Room height (recommended minimum ceiling height)	mm	2400
		<ul style="list-style-type: none"> With wall installation: with height less than 234,5 cm (92,32 in), limit the maximum travel at the installation With floor plate + wall installation: with room height less than 238,5 cm (93,89 in), limit the maximum travel at the installation

Room size (recommended minimum dimensions)	mm	2225 x 2015
---	----	-------------

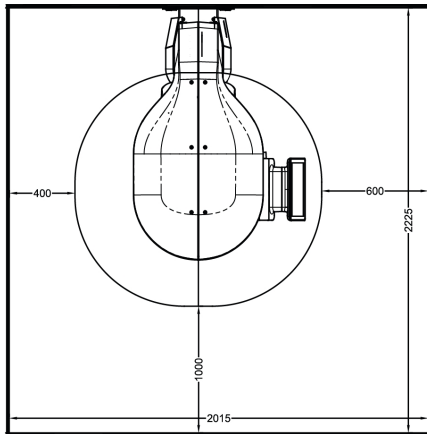

Floor shall bear the device weight, taking into account the following data:

Device weight	kg	120
Footprint	cm ²	658

Note: floor shall be solid, flat and suitable for bearing without deformation localized load. The technician in charge for installation shall evaluate the conditions of the floor and all the loads resting on the floor of the installation site.

WORKSTATION – NETWORK CONNECTION

Notice: All connectivity aspects are under the sole responsibility of the practice's IT management. W&H technicians are not authorized to access, modify, or configure workstations, PCs, or networks other than those provided by W&H. If intervention is required, contact the IT management.

- The practice must have a stable Internet connection. The acquisition workstation shall be connected to the practice network.
- The recommended network connection is a 1Gbit Ethernet (Cat6A minimum, Cat7 preferred). Wi-Fi connections are not permitted.
- The communication interface of the acquisition workstation is RJ45 for LAN cables.
- Verify the IP address of the practice network. If the IP address falls within the classes 172.30.30.0/24 or 172.30.40.0/24, contact IT management to change it.

WORKSTATION – MONITOR CONNECTION

W&H does not provide the monitor, nor the HDMI / DisplayPort cable.

- The minimum monitor size suggested is 15”, the recommended is 24”.
- The minimum resolution is 1920 x 1080, the recommended is 2560 x 1440.
- The monitor minimum recommended interface is HDMI 1.4 or DisplayPort1.2.

INSTALLATION SCENARIOS

It is possible to install seethrough studio alone, seethrough studio with Clinical Server, or All in One: seethrough studio and Clinical server together.

Additionally, there are two installation scenarios:

- First scenario: everything is installed in one workstation, both seethrough studio and Clinical Server. This means that it must be installed on Windows PRO (therefore considering the clinical server requirements to be more restrictive).
- Second scenario: seethrough studio and Clinical Servers are installed on two separate PCs and therefore have different requirements. For the client requirements see the tables below.

CLIENT REQUIREMENTS

Windows	Studio	Clinical Server	Studio + Clinical Server
OS Version	Windows 10/11 HOME 64-bit	Windows 10/11 PRO 64-bit	Windows 10/11 PRO 64-bit
CPU	Intel Core i7	Intel Core i5	Intel Core i7
Hard Drive	512 Tb	1 Tb	1 Tb
RAM	8 Gb [*]	16 Gb	16 Gb [*]
GPU	Integrated	Integrated	Integrated
GPU with AI	NVIDIA 4060 (6RTX Gb) [*]	N/A	NVIDIA 4060 (6RTX Gb) [*]
Ethernet interface	1x Gigabps Ethernet, 1x 100 Mbps Ethernet	1x Gigabps Ethernet, 1x 100 Mbps Ethernet	1x Gigabps Ethernet, 1x 100 Mbps Ethernet

An Internet connection is required for license activation.

[*] For a faster and better performance of the AI functionality, a NVIDIA 5060 Ti (16gb) GPU and 32gb RAM are recommended.

Product description

The seethrough^{FLEX} device is a radiographic medical device. X-rays are generated by an high voltage generator in a radiological tube located in a X-ray tube head. The region of interest (ROI) is scanned through a single rotation around the vertical axis of the patient head. Information are acquired from different angles. The software, then, processes information such as density and shape to construct tomographic images.

GENERAL VIEW

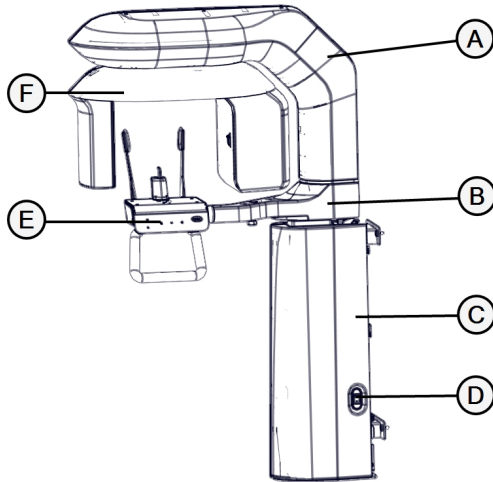

Part	Description
A	Fix arm
B	Patient support arm
C	Column + interface box
D	Power switch
C	Rotating core
E	On-board control panel

ROTATING CORE

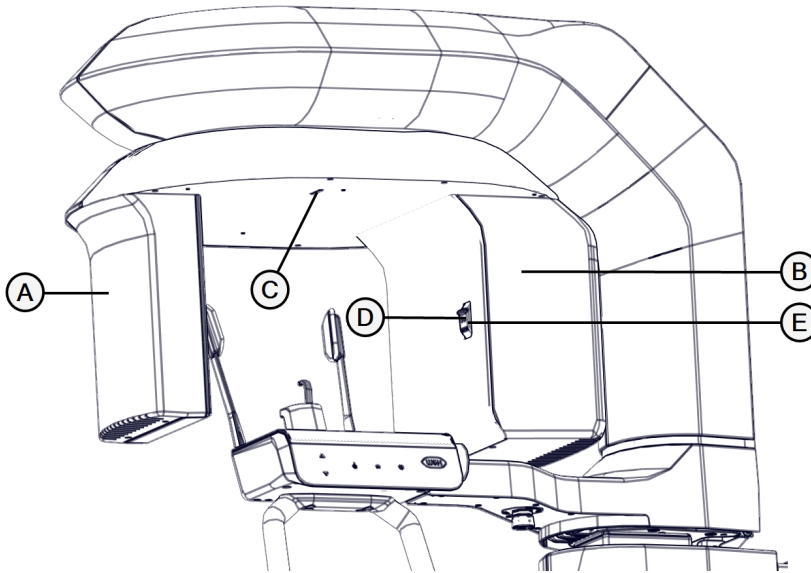

Part	Description
A	X-ray detector side
B	X-ray tube head side
C	Medio-sagittal laser
D	Frankfurt laser
E	Frankfurt laser rotary knob

Notice: medio-sagittal and Frankfurt lasers are class 1M lasers.

PATIENT SUPPORT ARM

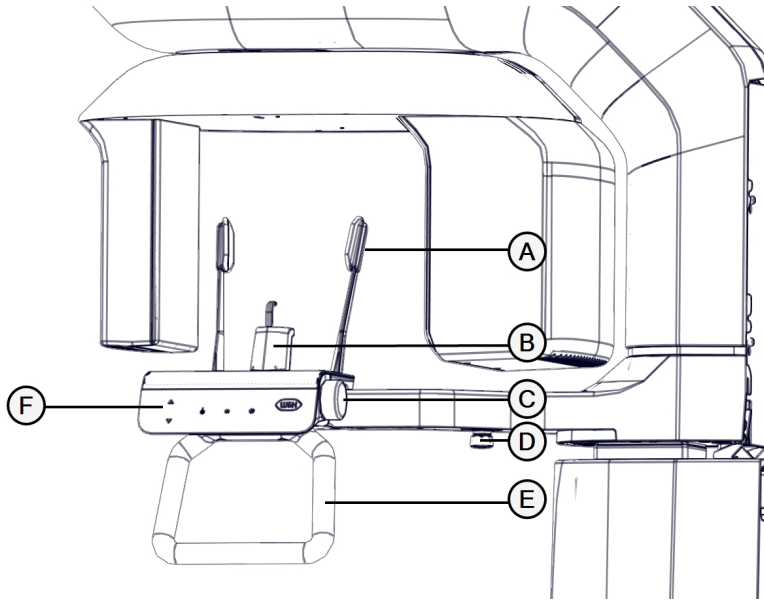

Part	Description
A	Temple supports
B	Chinrest (with specific components)
C	Temple supports knob
D	Emergency stop button*
E	Patient handle
F	On-board control panel: <ul style="list-style-type: none"> ■ Touchscreen ■ Capacitive keyboard See "On-board control panel" on the next page.

Notice *: When the emergency stop button is pressed:

- all the movements are interrupted,
- X-ray emission is interrupted,
- motor power circuits in the device are switched off,
- LEDs get yellow ("Capacitive keyboard LEDs" on page 32),
- a message pops up on the workstation to advice the user (see "Messages" on page 82).

ON-BOARD CONTROL PANEL

The seethrough^{FLEX} device is equipped either with a touchscreen or a capacitive keyboard for handling the machine.

Touchscreen

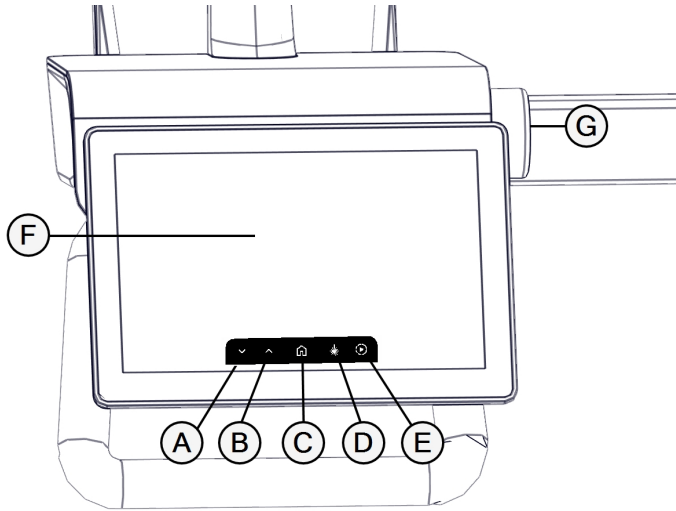

Part	Description
A	Stand movement upward
B	Stand movement downward
C	HOME button
D	Laser button
E	DEMO TEST button
F	Extra-oral acquisition module
G	Temple supports knob

Capacitive keyboard

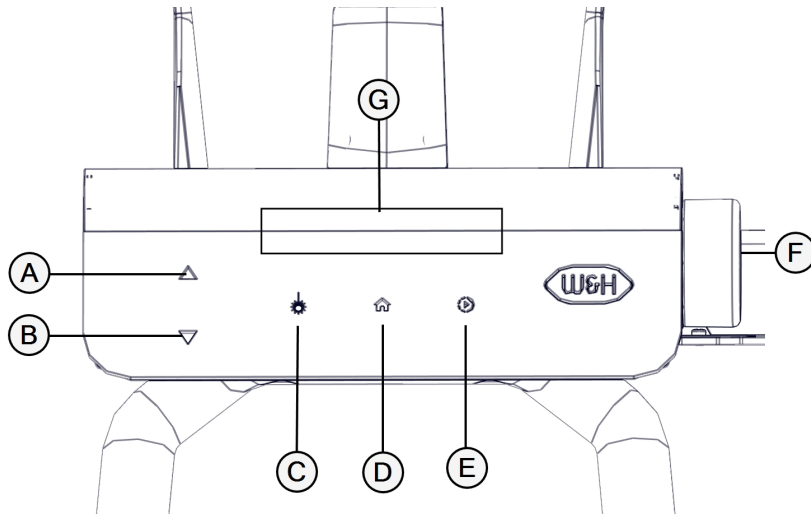

Part	Description
A	Stand movement upward
B	Stand movement downward
C	LASER button
D	HOME button
E	DEMO TEST button
F	Temple supports knob
G	LEDs

Note: Icon colors change consistently to the seethrough^{FLEX} device status (refer to "Capacitive keyboard LEDs " on the next page).

Capacitive keyboard LEDs

LEDs indicate the seethrough^{FLEX} status:

Color	Status
Blue	Idle
Green	Ready for use
Yellow	Caution
White	Power up or exam running

For more information about the device status, see "Diagnostics" on page 81.

Column movement upward/downward

Adapt the column height to the patient size using the two buttons; the patient has to lean his chin on the chinrest during the exam.

LASER button

The **LASER** button is a toggle to activate the seethrough^{FLEX} device lasers. Click the button to switch lasers on and click it again to switch them off. After 30 seconds the lasers will turn automatically off.

HOME button

The **HOME** button brings the seethrough^{FLEX} device in the PATIENT ENTRY POSITION:

PATIENT ENTRY POSITION is reached when the C-shaped rotating arm is perpendicular to the column with the X-ray tube head close to the column and the X-ray detector away from it

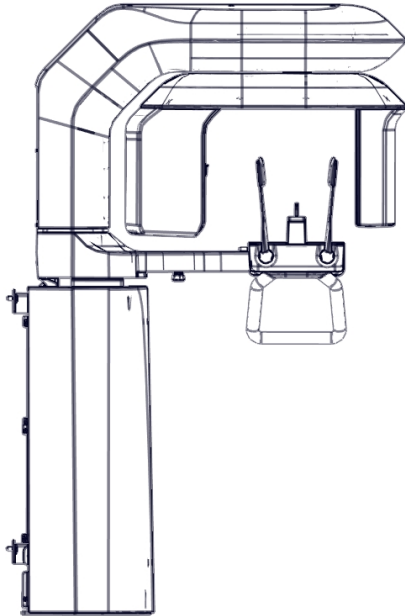

DEMO TEST button

The **DEMO TEST** button starts a simulation of the exam. The seethrough^{FLEX} device will execute all the movements necessary for performing the selected exam, but without emitting any X-ray. This modality can be used with particularly frightened patients, to reassure them and avoid any movements due to fear that can invalidate the exam.

Temple supports knob

Use the Temple supports knob to open and close the Temple supports to guarantee the right positioning of the patient. Turn the knob forward to close the temple supports. Turn it backward to open the temple supports. The rotation direction of the knob is indicated on it.

The system is set to stop when it encounters resistance. An automatic mechanism will adjust the clamping force. The system is calibrated to guarantee the correct positioning and the comfort of the patient at the same time.

At the end of the exam, the temple supports will automatically open releasing the patient from the exam position.



X-RAY COMMAND

The wall-mounted X-ray command is the standard option and is provided by default with each seethrough^{FLEX} device. This version is designed for fixed wall installation (not mobile) and integrates a dedicated set of LED indicators.

Alternatively, a mobile X-ray command (code 19740025) is available, supplied with a dedicated wall-mounted support equipped with LED indicators that display the system status.

Press the **X-Ray** button to start the exposure.

Note: a buzzer sound will be emitted as long as the X-ray emission is ON.

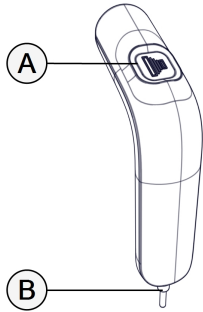

Mobile X-ray command

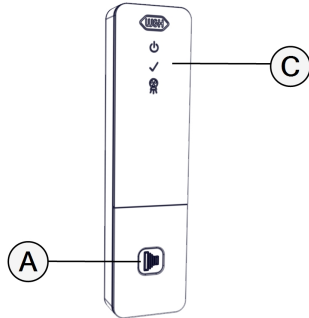



Wall-mounted X-ray command (Standard option)

Part	Description
A	X-Ray button
B	Coil cord
C	LED panel

Wall-mounted X-ray command LEDs

The LEDs indicate the device status:

LED	Color	Status
	White	seethrough ^{FLEX} powered ON
	Green	seethrough ^{FLEX} ready for X-ray emission
	Yellow	X-ray emission ongoing

COMPONENTS

Bite block

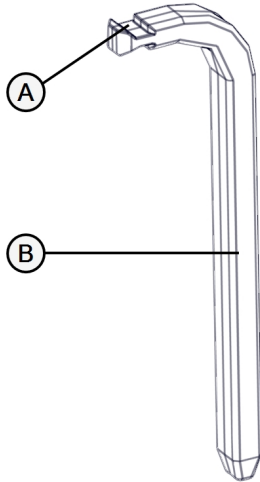

Part	Description
A	Groove for bite
B	Sliding part

Bite block installation

 **CAUTION!** The bite is autoclavable for up to 100 sterilization cycles at 121°C and must be sterilized after each use. Alternatively, disposable protective covers must be used.

As an alternative to sterilization, before each exam, the bite shall be covered with a new sterile disposable sheath. After each use, the sheath shall be disposed and the bite washed to remove any organic residue. Consult "User maintenance" on page 76 section for further information.

For installing the bite block:

Insert the bite block in the adapter slot.

Adjust the height of the bite block by sliding it up or down in the adapter slot.

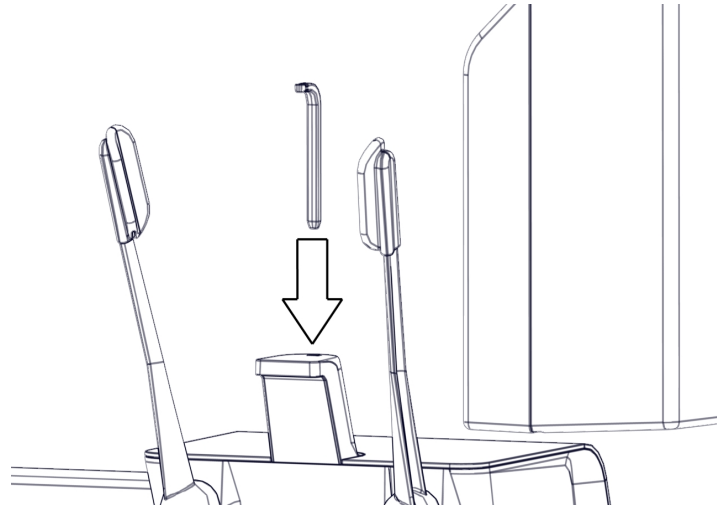

Edentulous/TMJ support



Part	Description
A	Pro-labium leaning space

Edentulous/TMJ support installation

For installing the Edentulous/TMJ support:

Insert the Edentulous/TMJ support in the adapter. Make sure it is firmly locked.

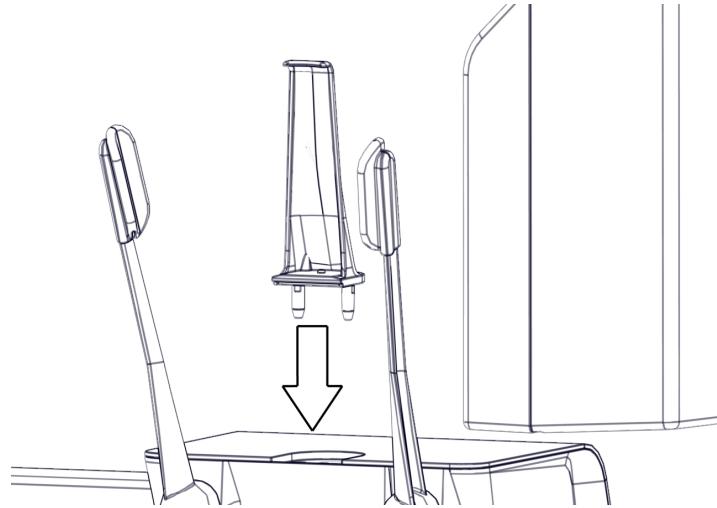

Chinrest

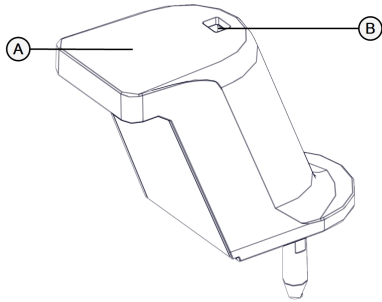

Part	Description
A	Flat surface for leaning the chin
B	Adapter slot for Bite block

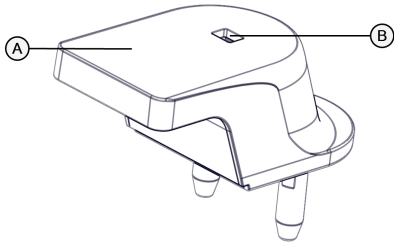

Ensure that the correct chinrest is placed in the designated slot before proceeding with the exam. An automatic recognition system will notify in seethrough studio the user if the mounted chinrest is not suitable for the selected exam type.

Chinrest installation

For installing the chinrest, whatever the size is:

Insert the chinrest in the adapter. Make sure it is firmly locked.

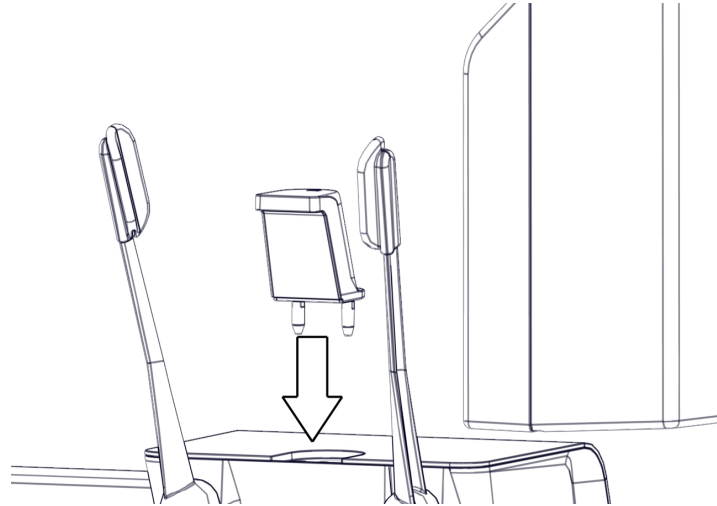

WORKSTATION

The Workstation supplied with the seethrough^{FLEX} device consists of a computer that interacts with the device.

The software seethrough studio is already installed in the provided Workstation. It acquires images from the X-ray detectors and processes all the data into 2D and 3D images.

For further information about seethrough^{FLEX}, refer to seethrough studio Instructions for Use.

Operating the unit

BEFORE SWITCHING THE SEETHROUGH^{FLEX} DEVICE ON

Check the device to confirm its integrity and ensure there are no visible signs of damage or malfunction.

Cables and covers shall be intact. The seethrough^{FLEX} device shall not have visible signs of tampering. The rotating arm shall be firmly attached to the fixed arm, with no dangling parts.

POWER THE SEETHROUGH^{FLEX} DEVICE ON

Press the power switch located in the base of the seethrough^{FLEX} device (see "General view" on page 27). Once switched **ON**, the on-board control panel will turn on and the LEDs will turn:

- Blue: if Homing is required.
- Green: if the device is ready to be used.
- Yellow: in case of warning.

Notice: Before entering the idle status, the device performs movements initialization and status checks.

POWER THE WORKSTATION ON

- 1** Press the power switch located in the Workstation.
- 2** Open the software seethrough studio.
- 3** Follow the instructions explained in the seethrough studio Instructions of Use to access the User profiles.

seethrough studio

seethrough^{FLEX} shall be used together with the seethrough studio software.

Access the software with the personal profile, create a new patient or access an existing one.

To perform a new exam use the **Acquisition module**.

To analyze a document use the **Analysis module**.

Create a report with the **Report module**.

Finally, export information with the **Export module**.

Refer to the seethrough studio Instructions of Use for information related to the software.

Operation

CONTENTS

This section deals with the following subjects:

Exam preparation	45
Preparing the device	55
Patient positioning	56
X-ray exposure	63
Exam evaluation	73
Power the unit OFF	74

Exam preparation

After choosing the exam to perform, a window pops up from the **Acquisition module** (refer to seethrough studio Instructions of Use).



CAUTION: Respect all the safety indications reported in the section "Radiation protection cautions" on page 13 to avoid patient/user overexposure to X-ray.

Notice: Radiological parameters, such as exam kV, mA and dose are always reported in the exam screen both in the upper black bar and in the central area of the screen.

For each exam, the specific procedure is reported.

Follow this workflow:

Phase	Description	Settings
1	Prepare the system	<ul style="list-style-type: none"> ■ If required, clean the system ■ If OFF, turn ON the device ■ If OFF, turn ON the workstation ■ Choose and mount the accessories
2	Choose the exam	<ul style="list-style-type: none"> ■ Panoramic exam ■ 3D Exam

Phase	Description	Settings
3	Set the exam parameters	<ul style="list-style-type: none"> ■ Patient size ■ Anatomic area ■ Dose refinement ■ Advanced parameters
4	Patient positioning	<ul style="list-style-type: none"> ■ Position the patient ■ Adjust stand height ■ Accessories configuration ■ Use the laser for the proper patient placement

EXAM DESCRIPTION AND EXAM PARAMETERS

Whichever exam chosen, the user interface on the workstation is divided into areas to help in configuring the exam:

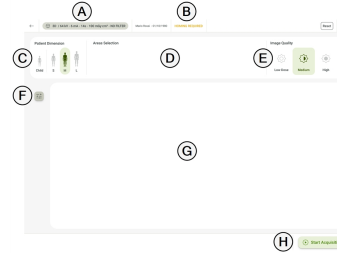

Part	Description
A	Exam recap
B	Device status
C	Patient dimension
D	Exam anatomical area
E	Image quality
F	Manual settings
G	Anatomical area window
H	Start acquisition button

Exam recap

In the upper bar, information related to the exam are reported. Find the kind of exam (2D or 3D), radiological parameters set (*i.e.*, kV and mA), dose and filtration used. Patient's information can be also found in the upper bar.

Go back to the previous menu by clicking on the arrow in the upper bar. Reset the original parameters clicking on **Reset**.

Device status

The device status is reported to know the status of the machine and whether it is necessary to undertake any action (*e.g.*, "press the homing button").

Patient dimension

Four different sizes are available:

- **Child**
- **Small-sized adult**
- **Medium-sized adult**
- **Large-Sized adult**



CAUTION: It is important to choose the real patient size. Possibly, dose can be adjusted by tuning advanced parameters.

Exam anatomical area

The exam anatomical area Tabs permits to easily switch among different exams corresponding to different anatomical macroareas.

Note: the software memorizes information when moving from one Tab to another.

Image quality

Set the image quality, choosing among:

- **Low Dose**
- **Medium**
- **High**

Manual settings

Settings provided automatically by the software are an optimization proposed by the manufacturer. Expert users can choose to finely set some radiological and geometrical parameters.

Click on the menu to open it.

2D exams:

- Edit the **Dose** by acting on kV and mA values,
- Patient-related parameters:
 - **Mouth Shape:** to choose the anatomical class of the patient (**Square** or **Sharp**),
 - **Incisors:** to choose a different incisor angle in case patients have protruding incisors.
- Trajectory:
 - **standard**,
 - **orthogonal:** to better distinguish even adjacent teeth, but producing more ghosting artifacts.

3D exams:

- Edit the **FOV** by acting on diameter and height (information on the new dose value are reported),
- Edit the **Dose** by acting on kV and mA values,



CAUTION: After manually editing FOV and dose, save the editing. If exiting without saving, editing will not be actuated. To go back to original parameters, click on **Reset** before saving.

- Change the denoise correction:
 - Off
 - Mid
 - HQ
- Change the metal artifact reduction (MAR):
 - Off
 - Auto
 - Dual

Anatomical area window

In this section there is a scheme with the anatomical district interested by the specific exam. Select the part to investigate, that turns green. Only sensible combinations are available.

EXAM TYPES

Panoramic Dental arch

Exam description

Dental arch exam is a partial or complete exam of patient's teeth.

It is performed as a general screening or to investigate abscesses, cysts, periodontitis, bone resorption, interproximal caries, bone resorption or teeth growth in children.

Exam parameters

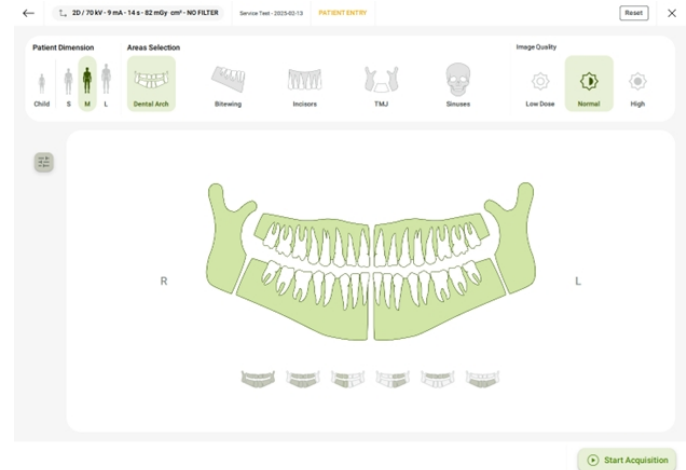

When a child size is chosen, a child mouth appears on the screen.

Use fast selections for pre-set specific areas of the dental arch. Alternatively, select directly on the mouth representation the target area by clicking on it.

In case the selection is not correct (e.g., not adjacent areas or not available combinations of areas have been chosen), the **Start Acquisition** button deactivates and the exam cannot be completed.

Select at least one anatomical area to perform the exam, otherwise the **Start Acquisition** button is deactivated and the execution of exam is not allowed.

Among the advanced parameters settable parameters are:

- quality-related dose,
- mouth shape,
- tooth protruding,
- trajectory adjustment,

Bitewing

Exam description

Bitewing exam is a 2D image of a specific region of patient's teeth (*i.e.*, the molars teeth). It can be used for specific clinical purposes, such as examination of inter-proximal caries.

Exam parameters

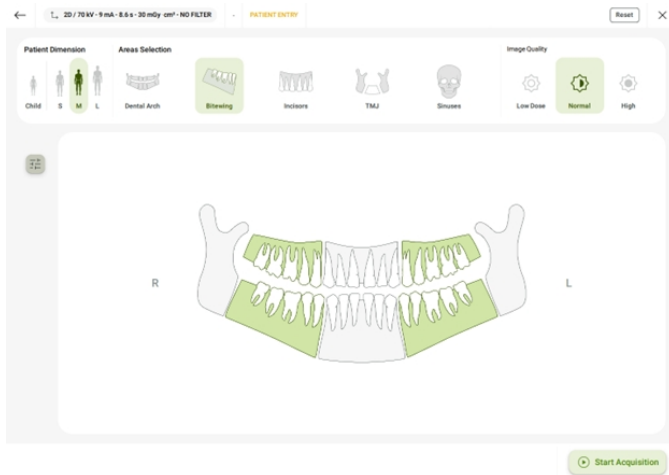

When a child size is chosen, a child mouth appears on the screen.

Select directly on the mouth representation the target area by clicking on it.

Select at least one anatomical area to perform the exam, otherwise the **Start Acquisition** button is deactivated and the execution of exam is not allowed.

Among the advanced parameters settable parameters are:

- quality-related dose,
- mouth shape,
- tooth protruding,

Panoramic TMJ

Exam description

Temporomandibular junction exam (TMJ) targets mandibular joint. The aim of the exam is to investigate temporomandibular joint dysfunction.

Exam parameters

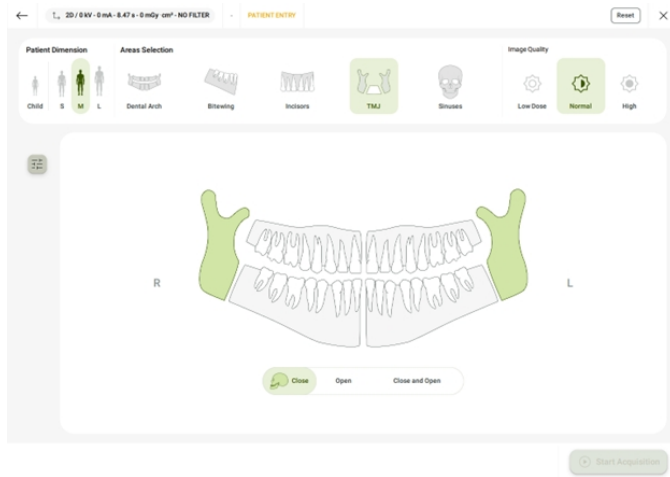

When a child size is chosen, a child mouth appears on the screen. Below the anatomical area window, three mouth positions are available:

- only close mouth: the patient's mouth is closed in a normal occlusion position.
- only open mouth: the patient's mouth is fully open to assess the condylar translation.
- both open and close mouth: two exams are taken: one with the mouth closed and one with the mouth open, to compare condylar positions.

Among the advanced parameters settable parameters are:

- quality-related dose,

Panoramic Sinuses

Exam description

Sinus exam does not interest the area of teeth, but it is related to:

- maxillary sinuses,
- frontal sinuses.

The aim of the study is investigating any sinusitis or upper airway infections.

Exam parameters

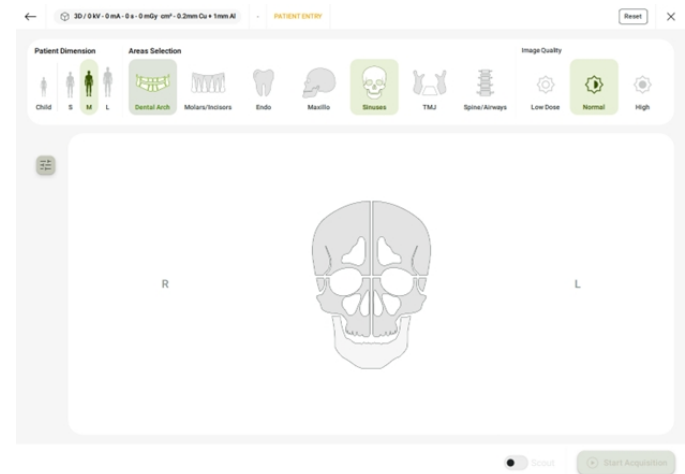

In case the selection is not correct (e.g., not adjacent areas or not available combinations of areas have been chosen), the **Start Acquisition** button deactivates and the exam cannot be completed.

Select on the head representation the target area by clicking on it.

Multiple selections are available:

- only maxillary sinuses,
- only frontal sinuses,
- only left sinuses (both maxillary and frontal),
- only right sinuses (both maxillary and frontal),
- the whole paranasal sinuses area,
- one specific sinus.

Select at least one anatomical area to perform the exam, otherwise the **Start Acquisition** button is deactivated and the execution of exam is not allowed.

Among the advanced parameters settable parameters are:

- quality-related dose,

3D Dental arch

Exam description

Dental arch exam is a partial or complete exam of patient's teeth.

It is performed to plan any dental implant surgery or tooth extraction.

Exam parameters

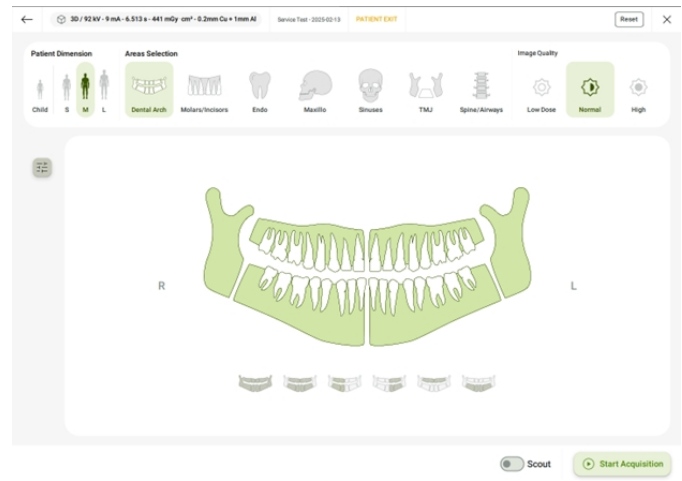

When a child size is chosen, a child mouth appears on the screen.

Use fast selections for pre-set specific areas of the dental arch. Alternatively, select directly on the mouth representation the target area by clicking on it.

In case the selection is not correct (e.g., not adjacent areas or not available combinations of areas have been chosen), the **Start Acquisition** button deactivates and the exam cannot be completed.

Increase the volume of interest to extend the scanned volume.

Select at least one anatomical area to perform the exam, otherwise the **Start Acquisition** button is deactivated and the execution of exam is not allowed.

Among the advanced parameters settable parameters are:

- quality-related dose,
- denoise,
- metal artifact reduction (MAR).

3D Molar/Incisors

3D Individual Teeth – ENDO

Exam description

Individual tooth exam permits to acquire a small specific volume around minimum three patient's teeth on a single dental arch, or six patient's teeth on both dental arches.

This exam is used in endodontics and root canal therapy.

Exam parameters

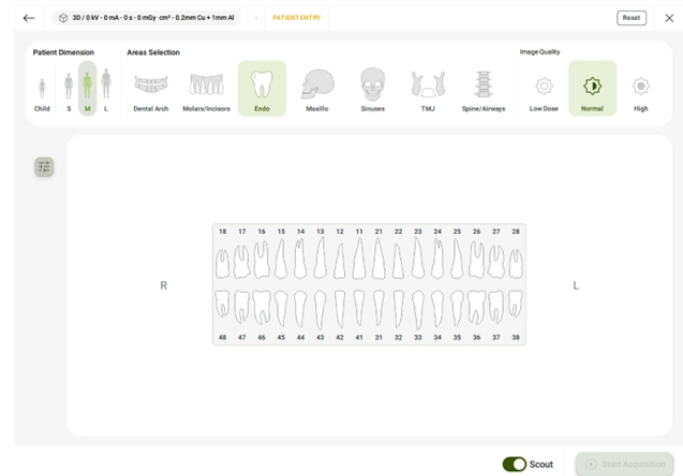

When a child size is chosen, a child mouth appears on the screen.

Select directly on the mouth representation the target area by clicking on it.

Select groups of maximum three adjacent teeth belonging to the same arch or groups of maximum six teeth (three per arch). A fast selection can be done by clicking teeth not adjacent: if the combination is sensitive, teeth between get automatically selected. Likewise, deselection is guided.

Increase the volume of interest to extend the scanned volume.

Select at least one tooth to perform the exam.

Among the advanced parameters settable parameters are:

- quality-related dose,
- denoise,
- metal artifact reduction (MAR).

3D Full Head

Exam description

The full head exam targets the volume of the head.

Its scope is maxillofacial surgery.

Exam parameters

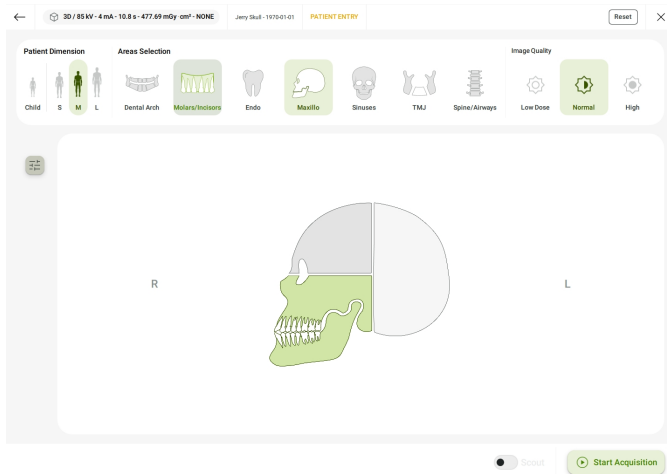

Select on the head representation the target area by clicking on it.

Once set, the **READY** button is activated. If the **READY** button is deactivated, it is missing the selection of the anatomical area; in this case the execution of the exam is not allowed.

Among the advanced parameters settable parameters are:

- quality-related dose,
- denoise,
- metal artifact reduction (MAR).

3D Sinuses

Exam description

Sinus exam does not interest the area of teeth, but it is related to:

- maxillary sinuses,
- frontal sinuses.

Exam parameters

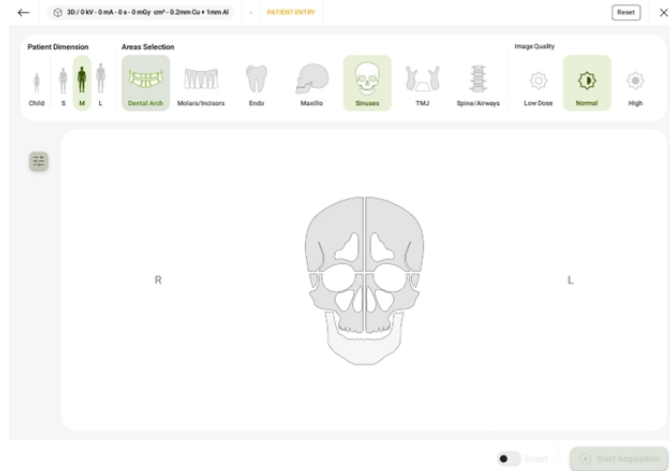

Select on the head representation the target area by clicking on it.

Multiple selections are available:

- only maxillary sinuses,
- only frontal sinuses,
- only left sinuses (both maxillary and frontal),
- only right sinuses (both maxillary and frontal),
- the whole paranasal sinuses area,
- one specific sinus.

Increase the volume of interest to extend the scanned volume.

Select at least one anatomical area to perform the exam, otherwise the **Start Acquisition** button is deactivated and the execution of exam is not allowed.

Among the advanced parameters settable parameters are:

- quality-related dose,
- denoise,
- metal artifact reduction (MAR).

3D TMJ

Exam description

Temporomandibular junction exam (TMJ) targets mandibular joint. The aim of the exam is to investigate temporomandibular joint dysfunction.

Exam parameters

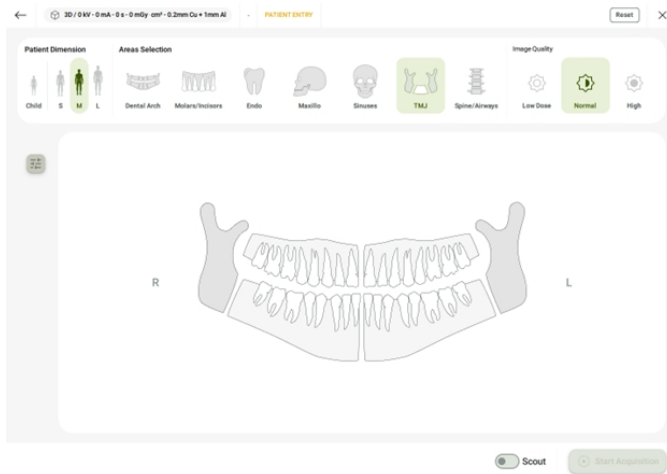

When a child size is chosen, a child mouth appears on the screen. Select on the head representation the target area by clicking on it. Increase the volume of interest to extend the scanned volume. Select only one side at one time. Select at least one anatomical area to perform the exam, otherwise the **Start Acquisition** button is deactivated and the execution of exam is not allowed.

Among the advanced parameters settable parameters are:

- quality-related dose,
- denoise,
- metal artifact reduction (MAR).

3D Airways and Spine

Exam description

The airway or spine exam focuses on a specific volume of the head.

The scope is investigating upper airways diameters and analyzing cervical vertebrae.

Exam parameters

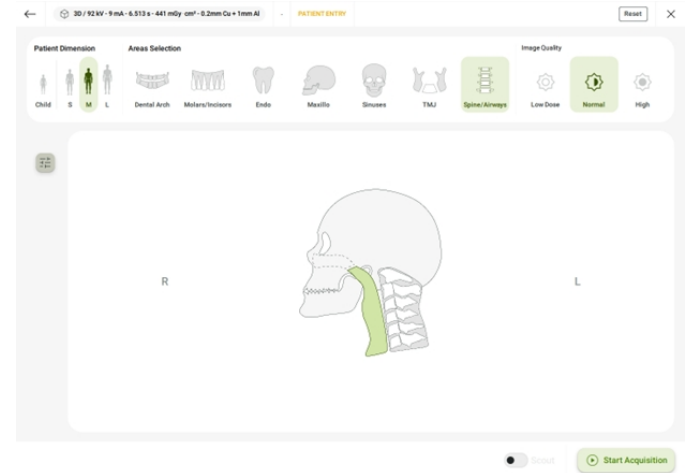

Select on the head representation the target area by clicking on it.

Increase the volume of interest to extend the scanned volume.

Select airways or spine one at one time.

Select at least one anatomical area to perform the exam, otherwise the **Start Acquisition** button is deactivated and the execution of exam is not allowed.

Among the advanced parameters settable parameters are:

- quality-related dose,
- denoise,
- metal artifact reduction (MAR).

START ACQUISITION BUTTON

Once confident about all the exam settings, click on **Start Acquisition** button.

A new window pops up with a recap of the parameters set in the previous phase. Anatomical, radiological and any advanced parameters are shown.

In case homing is required, the **device status** ("Device status" on page 46) could be **HOMING REQUIRED** or **PATIENT EXIT** and after clicking the **Start Acquisition** button a message pops up:

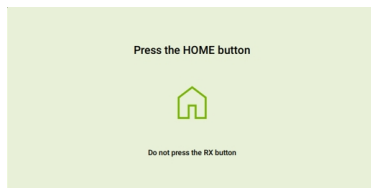

Go to the device and click the **HOME** button on the On-board control panel ("On-board control panel" on page 30). Therefore, in the "device status" windows it is visible the message **MOVING** and finally **PATIENT ENTRY**.

Before X-ray emission, it is necessary to prepare the device and accompany the patient to the device.

Preparing the device



CAUTION: Before starting the exam, make sure that the device is cleaned, as reported in "Cleaning and disinfection by the user" on page 76

Panoramic exam: Dental arch and Bitewing

To properly perform the exam, mount the Bite block.

Note For mounting instructions, see "Product description" on page 27.

Panoramic exam: TMJ and Sinuses

To properly perform the exam, mount the Edentulous/TMJ support.

Note For mounting instructions, see "Product description" on page 27.

3D exams



No components are mandatory for properly performing the exam, but the use of the bite block may help in avoiding unwanted movements from the patient.



Patient positioning

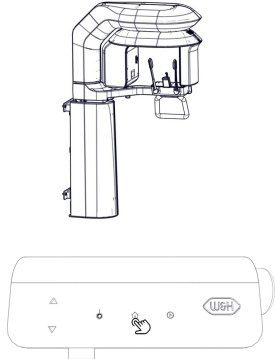

CAUTION: This phase requires the use of a laser to help positioning the patient. Avoid to direct laser to anyone's eyes.
 Before accompany the patient to the seethrough^{FLEX} device, ask them to remove glasses and any earrings or jewelry.

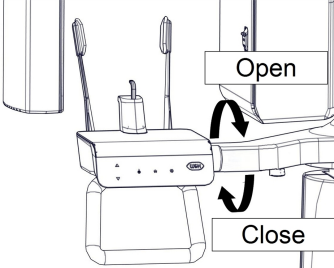
PANORAMIC EXAM: DENTAL ARCH AND BITEWING

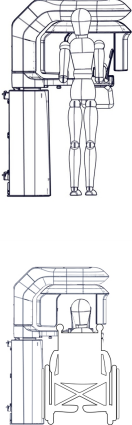
Reference	Description
	<p>seethrough^{FLEX} shall be in the PATIENT ENTRY POSITION, if not, click the HOME button on the On-board control panel.</p> <p> CAUTION: Do not let the patient get closer to the device before HOME button has been pressed.</p>
	<p>Temple supports shall be open to help the patient positioning in the seethrough^{FLEX} device. If not, rotate the knob to automatically open them.</p>

Reference	Description
	<p>Help the patient reaching the device, where they grab the handle and leans the chin on the chinrest.</p> <p> Be careful nobody crushes their hands into the device during the positioning.</p> <p>If the the patient has a disability, uses a wheelchair, or has mobility difficulties, they can be positioned while seated.</p>

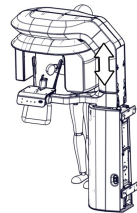
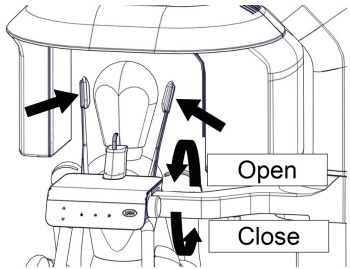

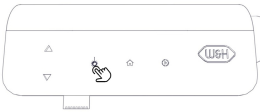
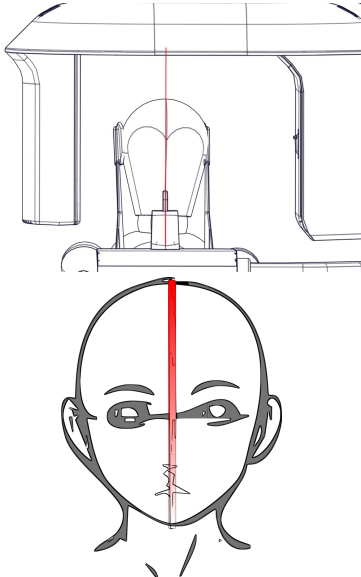
Reference	Description
 	<p>Adjust the stand height through the On-board control panel buttons to fit the patient size.</p>
	<p>Close the temple supports. Rotate the knob to automatically close the temple supports. The system is set to stop when it encounters resistance. The system is calibrated to guarantee the correct positioning and the comfort of the patient at the same time.</p>



Reference	Description
	<p>Light the lasers on.</p>
	<p><i>Mediosagittal laser</i> shall be positioned in the patient face centerline. If not, gently rotate the patient head from left to right or vice-versa [refer to seethrough studio Instructions of Use].</p>

To limit artifacts in the images, ask the collaboration of the patient who should keep the tongue on the palate and avoid any movements

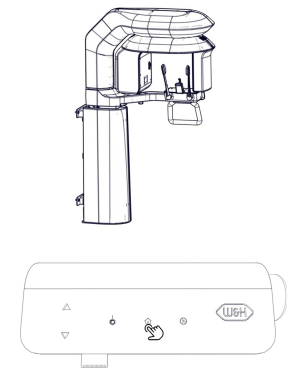
Notice: in case of particularly frightened patients, start a demo exam, without X-ray emission, clicking the **DEMO TEST** button.

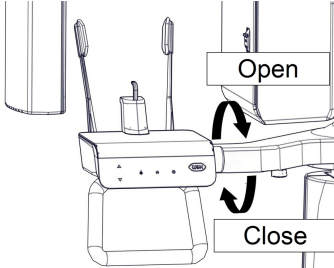
PANORAMIC EXAM: TMJ AND SINUSES

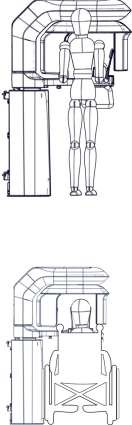
Reference	Description
	<p>seethrough^{FLEX} shall be in the PATIENT ENTRY POSITION, if not, click the HOME button on the On-board control panel.</p> <p> CAUTION: Do not let the patient get closer to the device before HOME button has been pressed.</p>
	<p>Temple supports shall be open to help the patient positioning in the seethrough^{FLEX} device. If not, rotate the knob to automatically open them.</p>

Reference	Description
	<p>Help the patient reaching the device, where they grab the handle and leans the chin on the chinrest.</p> <p> Be careful nobody crushes their hands into the device during the positioning.</p> <p>If the the patient has a disability, uses a wheelchair, or has mobility difficulties, they can be positioned while seated.</p>

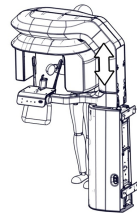
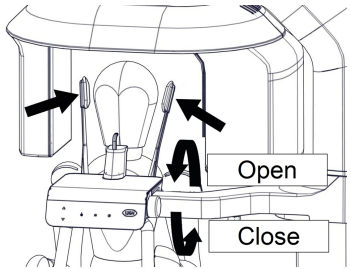

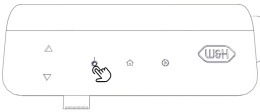
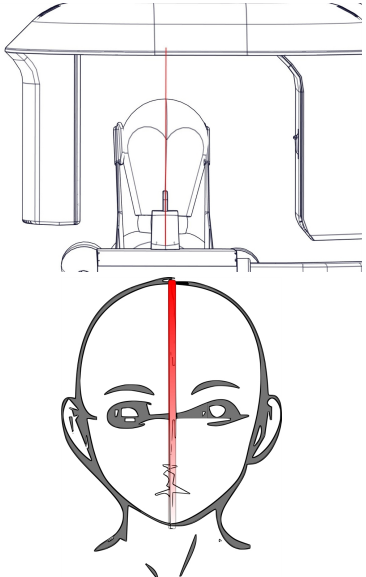
Reference	Description
 	<p>Adjust the stand height through the On-board control panel buttons to fit the patient size.</p>
	<p>Close the temple supports. Rotate the knob to automatically close the temple supports. The system is set to stop when it encounters resistance. The system is calibrated to guarantee the correct positioning and the comfort of the patient at the same time.</p>



Reference	Description
	<p>Light the lasers on.</p>
	<p><i>Mediosagittal laser</i> shall be positioned in the patient face centerline. If not, gently rotate the patient head from left to right or vice-versa [refer to seethrough studio Instructions of Use].</p>

To limit artifacts in the images, ask the collaboration of the patient who should keep the tongue on the palate and avoid any movements

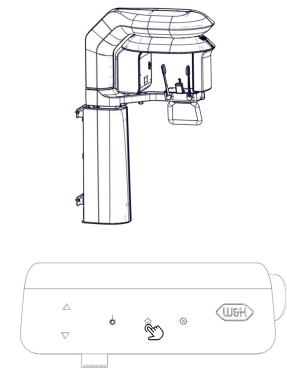
Notice: in case of particularly frightened patients, start a demo exam, without X-ray emission, clicking the **DEMO TEST** button.

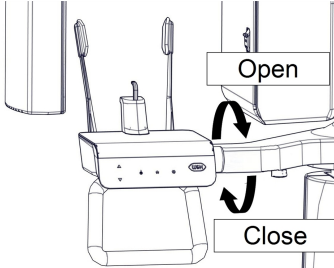
3D EXAMS

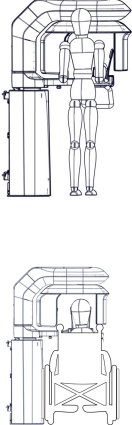
Reference	Description
	<p>seethrough^{FLEX} shall be in the PATIENT ENTRY POSITION, if not, click the HOME button on the On-board control panel.</p> <p> CAUTION: Do not let the patient get closer to the device before HOME button has been pressed.</p>
	<p>Temple supports shall be open to help the patient positioning in the seethrough^{FLEX} device. If not, rotate the knob to automatically open them.</p>

Reference	Description
	<p>Help the patient reaching the device, where they grab the handle and leans the chin on the chinrest.</p> <p> Be careful nobody crushes their hands into the device during the positioning.</p> <p>If the the patient has a disability, uses a wheelchair, or has mobility difficulties, they can be positioned while seated.</p>

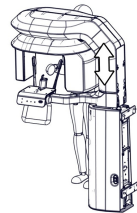
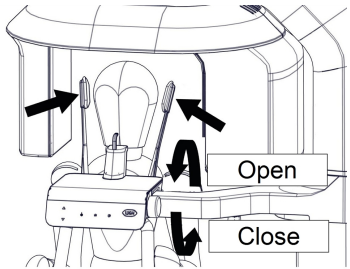
Reference	Description
 	<p>Adjust the stand height through the On-board control panel buttons to fit the patient size.</p>
	<p>Close the temple supports. Rotate the knob to automatically close the temple supports. The system is set to stop when it encounters resistance. The system is calibrated to guarantee the correct positioning and the comfort of the patient at the same time.</p>

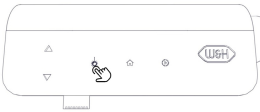
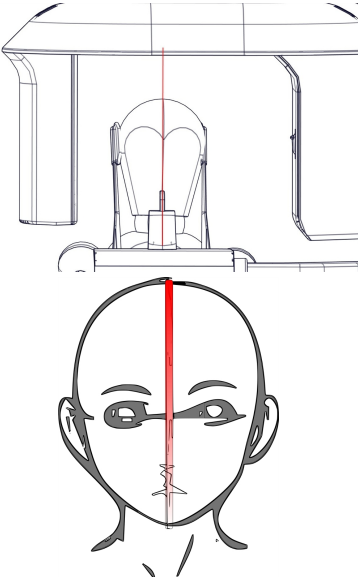
Reference	Description
	<p>Light the lasers on.</p>
	<p><i>Mediosagittal laser</i> shall be positioned in the patient face centerline. If not, gently rotate the patient head from left to right or vice-versa [refer to seethrough studio Instructions of Use].</p>

To limit artifacts in the images, ask the collaboration of the patient who should keep the tongue on the palate and avoid any movements

Notice: in case of particularly frightened patients, start a demo exam, without X-ray emission, clicking the **DEMO TEST** button.

If not previously done, before starting the X-ray emission, press the Homing button. If the Homing was not performed, the following pop up will inform the user to do it

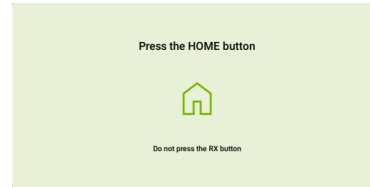

If not already closed, before starting the X-ray emission, close the door. If the door is open, the following pop up will inform the user to close it

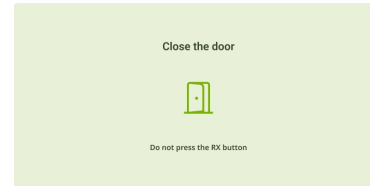

Finally, a new window pops up for preparing to X-ray emission:

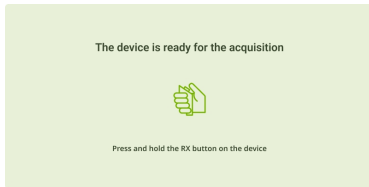

CHINREST USE

Chinrest Type	Chinrest Type	3D Exams (CBCT)
Low Chinrest	Panoramic X-ray (2D Pano)	<ul style="list-style-type: none"> ■ Full Bitewing ■ Posterior mandibular regions ■ Mandibular implant planning ■ Inferior alveolar nerve canal ■ Impacted lower third molars ■ TMJ – mouth open
High Chinrest	Not typically used in standard 2D exams	<ul style="list-style-type: none"> ■ Maxillo ■ Maxillary implant planning ■ Maxillary sinuses ■ Anterior region (incisors/canines) ■ Airway analysis ■ TMJ – mouth closed

X-ray exposure

Ask the patient not to move.

Stay into the radiation-protected area, where there is the X-ray button. The determination of the radiation-protected area falls exclusively under the responsibility of the user's designated qualified expert and may be subjected to variation in accordance with applicable regulations









CAUTION! The X-ray button is a dead-man equipment. In case of any problems, release immediately the button and the device will arrest the X-ray emission. A buzzer sound will be emitted as long as the button is pressed. In case the X-ray button is released earlier, the exam could be repeated from the beginning. During X-ray emission, never lose the visual contact with the patient (see "Radiation protection cautions" on page 13).

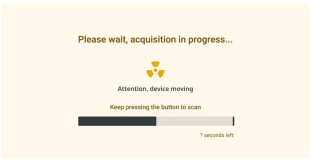

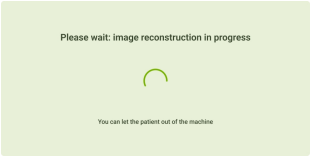
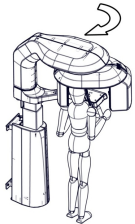

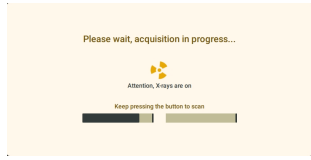

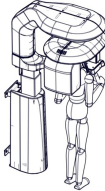
DENTAL ARCH, BITEWING AND SINUSES EXAMS

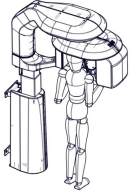

The exam starts right after pressing the X-ray button. Do not release it until the exposure is complete. In case of early release, an error message will appear: "Error: X-ray button was released too early!"

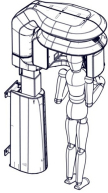
	<p>The rotating arm starts rotates clockwise to reach the START POSITION.</p>
	<p>The X-ray window pops up with the symbol of radiation and a bar with the percentage of completion. An acoustic signal indicates that X-ray emission is in progress. Do not release the button. A summary of exam parameters is always shown on the screen. The device status is EXAM.</p>
	<p>Press the X-Ray button and keep it pressed as long as the exam is finished.</p>
	<p>The exam starts: the rotating arm rotates counterclockwise.</p>

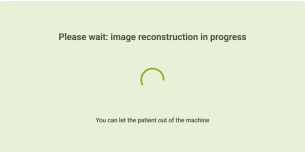

	<p>On the workstation the X-ray window pops up with the symbol of radiation and a bar with the percentage of completion. An acoustic signal indicates that X-ray emission is in progress. Do not release the button. A summary of exam parameters is always shown on the screen.</p>
	<p>A message will let you know when the acquisition is complete.</p>
	<p>At the end of X-ray emission a new window shows the image reconstruction progress.</p>
	<p>After the emission, hold the X-Ray button and the rotating arm rotates clockwise to reach the PATIENT EXIT POSITION (X-ray tube head and detector are in a symmetrical position if compared to PATIENT ENTRY POSITION). Notice: In case the X-Ray button is released after the emission but before reaching the EXIT POSITION, a pop-up reminds to press the HOME button again to go the ENTRY POSITION.</p>

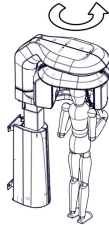
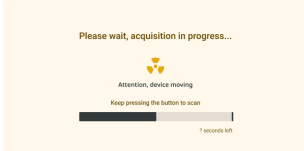

	<p><i>With scout images mode selected:</i> on the workstation, the X-ray window pops up with the symbol of radiation and a bar with the percentage of completion. An acoustic signal indicates that X-ray emission is in progress. Do not release the button. A summary of exam parameters is always shown on the screen.</p>	
	<p>The seethrough MAXseethroughFLEX acquires two scout images: 1. X-ray detector perpendicular to patient nose (direction A-P)</p>	

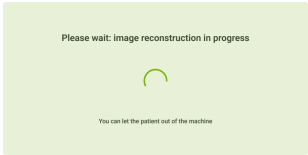
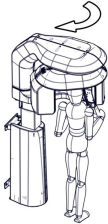
	<p>2. X-ray detector perpendicular to patient ear (direction L-R)</p>	
	<p>At the end of X-ray emission the device gets to the PATIENT ENTRY POSITION.</p>	
	<p>A new window shows the image reconstruction progress.</p>	

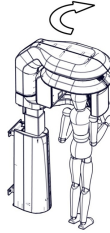
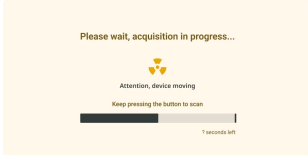
	<p>The scout images are shown on the screen. Select the ROI on the scout image:</p> <ul style="list-style-type: none"> ■ move the center of ROI, ■ adjust the borders, <p>by dragging and dropping them both in the coronal and in the sagittal planes. If necessary retake the scout images by clicking on the specific button.</p>	
	<p>The exam starts: the rotating arm rotates counterclockwise.</p>	
	<p>On the workstation the X-ray window pops up with the symbol of radiation and a bar with the percentage of completion. An acoustic signal indicates that X-ray emission is in progress. Do not release the button. A summary of exam parameters is always shown on the screen.</p>	

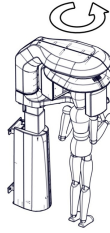
	<p>A message will let you know when the acquisition is complete.</p>
	<p>At the end of X-ray emission a new window shows the image reconstruction progress.</p>
	<p>After the emission, hold the X-Ray button and the rotating arm rotates clockwise to reach the PATIENT EXIT POSITION (X-ray tube head and detector are in a symmetrical position if compared to PATIENT ENTRY POSITION).</p> <p>Notice: In case the X-Ray button is released after the emission but before reaching the EXIT POSITION, a pop-up reminds the user to press the HOME button to go the ENTRY POSITION.</p>

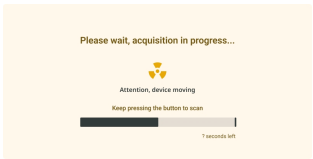
	<p>The rotating arm starts rotates clockwise to reach the START POSITION.</p>
	<p>The X-ray window pops up with the symbol of radiation and a bar with the percentage of completion. An acoustic signal indicates that X-ray emission is in progress. The user shall not release the button. A summary of exam parameters is always shown on the screen.</p>
	<p>Press the X-Ray button and keep it pressed as long as the exam is finished.</p>
	<p>The exam starts: the rotating arm rotates counterclockwise and the LED light turns yellow.</p>

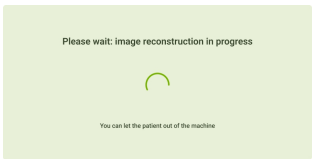

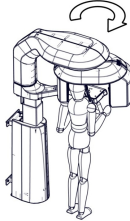
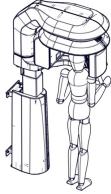
	<p>On the workstation the X-ray window pops up with the symbol of radiation and a bar with the percentage of completion. An acoustic signal indicates that X-ray emission is in progress. Do not release the button. A summary of exam parameters is always shown on the screen.</p>
	<p>A message will let you know when the acquisition is complete.</p>
	<p>At the end of X-ray emission a new window shows the image reconstruction progress.</p>

	<p>Ask the patient to be still and, in case, to open/close their mouth and push again the X-ray button. The machine rotates clockwise to perform a second acquisition.</p>
	<p>After the emission, the machine is back in the PATIENT ENTRY POSITION.</p>



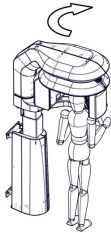
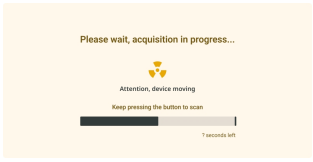
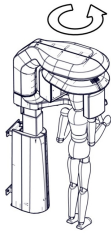

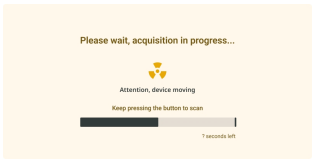
TMJ EXAM

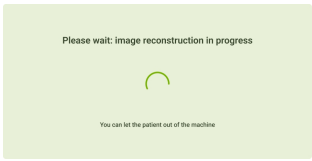
The exam starts right after pressing the X-ray button. Do not release it until the exposure is complete. In case of early release, an error message will appear: "Error: X-ray button was released too early!"

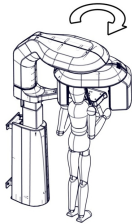
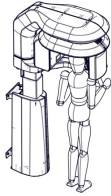
	<p>The rotating arm starts rotates clockwise to reach the START POSITION.</p>
	<p>The X-ray window pops up with the symbol of radiation and a bar with the percentage of completion. An acoustic signal indicates that X-ray emission is in progress. The user shall not release the button A summary of exam parameters is always shown on the screen</p>
<p>.</p>	<p>Press the X-Ray button and keep it pressed as long as the exam is finished.</p>
	<p>The exam starts: the rotating arm rotates counterclockwise and the LED light turns yellow.</p>

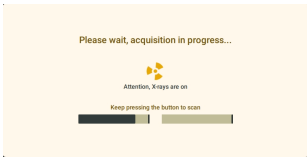

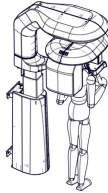



	<p>On the workstation the X-ray window pops up with the symbol of radiation and a bar with the percentage of completion. An acoustic signal indicates that X-ray emission is in progress. Do not release the button. A summary of exam parameters is always shown on the screen.</p>
	<p>A message will let you know when the acquisition is complete.</p>
	<p>At the end of X-ray emission a new window shows the image reconstruction progress.</p>

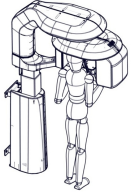

	<p>Ask the patient to be still and, in case, to open/close their mouth and push again the X-ray button. The machine rotates clockwise to perform a second acquisition.</p>
	<p>After the emission, the machine is back in the PATIENT ENTRY POSITION.</p>

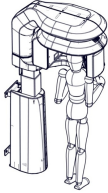
	<p><i>With scout images mode selected:</i> on the workstation, the X-ray window pops up with the symbol of radiation and a bar with the percentage of completion. An acoustic signal indicates that X-ray emission is in progress. Do not release the button. A summary of exam parameters is always shown on the screen.</p>	
	<p>The seethrough MAXseethroughFLEX acquires two scout images: 1. X-ray detector perpendicular to patient nose (direction A-P)</p>	

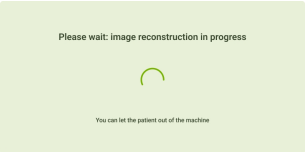
3D EXAMS

The exam starts right after pressing the X-ray button. Do not release it until the exposure is complete. In case of early release, an error message will appear: "Error: X-ray button was released too early!"

	<p>2. X-ray detector perpendicular to patient ear (direction L-R)</p>	<p> Scout</p>
	<p>At the end of X-ray emission the device gets to the PATIENT ENTRY POSITION.</p>	<p> Scout</p>
	<p>A new window shows the image reconstruction progress.</p>	<p> Scout</p>

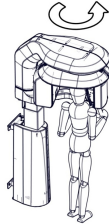
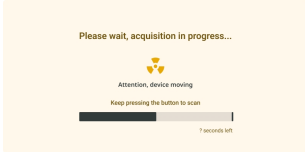
	<p>The scout images are shown on the screen. Select the ROI on the scout image:</p> <ul style="list-style-type: none"> ■ move the center of ROI, ■ adjust the borders, <p>by dragging and dropping them both in the coronal and in the sagittal planes. If necessary retake the scout images by clicking on the specific button.</p>	<p> Scout</p>
	<p>The exam starts: the rotating arm rotates counterclockwise.</p>	
	<p>On the workstation the X-ray window pops up with the symbol of radiation and a bar with the percentage of completion. An acoustic signal indicates that X-ray emission is in progress. Do not release the button. A summary of exam parameters is always shown on the screen.</p>	

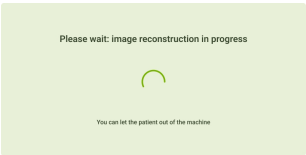
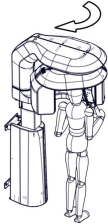
	<p>A message will let you know when the acquisition is complete.</p>
	<p>At the end of X-ray emission a new window shows the image reconstruction progress.</p>
	<p>After the emission, hold the X-Ray button and the rotating arm rotates clockwise to reach the PATIENT EXIT POSITION (X-ray tube head and detector are in a symmetrical position if compared to PATIENT ENTRY POSITION).</p> <p>Notice: In case the X-Ray button is released after the emission but before reaching the EXIT POSITION, a pop-up reminds the user to press the HOME button to go the ENTRY POSITION.</p>

Exam evaluation

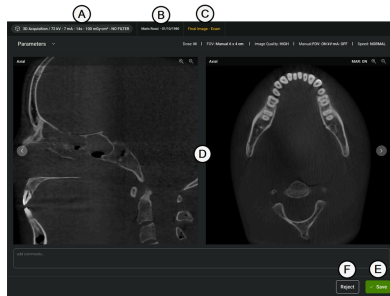

Part	Description
A	Parameter recap
B	Patient name
C	Device status
D	Document pre-view
E	Confirm button
F	Rejecting button

Document pre-view

Examine the quality of the image to decide whether to keep it or to reject it and re-do the exam.

Save menu

If the quality is fine, save the document.

In case the document is saved, the exam can be concluded.

At the end of the exam, temple support will automatically open. Assist the patient in stepping back/moving back from the device and leaving the examination area.

Rejecting menu

In case the quality is not good enough, reject it. It is mandatory to add a reason for rejecting, choosing among a list or adding a specific comment.



CAUTION: In case an exam is rejected, it shall be repeated (with resultant exposure of the patient).

Power the unit OFF

POWER THE WORKSTATION OFF

- 1 Save all the necessary data.
- 2 Close the program.
- 3 Switch OFF the workstation.

POWER THE DEVICE OFF

- 1 Press the power switch located in the base.

Maintenance

CONTENTS

This section deals with the following subjects:

Cautions for maintenance operations	75
Ordinary maintenance	75
User maintenance	76
Disposal	80

Cautions for maintenance operations

CAUTIONS FOR CLEANING



CAUTION: To avoid harm to patients, all the parts in contact with the patient shall be cleaned, disinfected or prepared according to the following indications.
Use only the disinfectants approved by the manufacturer, to avoid damages to the patient consequent to seethrough^{FLEX} device deterioration.
During cleaning or disinfecting, liquid can enter the unit.
Always avoid spraying any liquids directly on the machine, especially close to ventilation slots or other parts in contact with electrical components.

CAUTIONS FOR MAINTENANCE



CAUTION: Turn the seethrough^{FLEX} device OFF and open the thermal-magnetic residual-current circuit breaker before beginning any maintenance.
Follow all health, safety, cross-infection and cross-contamination protocols.
Maintenance operation shall be done at illumination level of 215 lx (± 15 lx) to 1500 lx (± 15 lx).
Before making any operation, ward off unauthorized personnel from the working area.
Laser maintenance shall be carried out only by trained technicians.



CAUTION: Before touching any surfaces of components where X rays are produced, be sure the seethrough^{FLEX} device component is cold.

Notice: Follow the instructions in this chapter when carrying out any maintenance on the seethrough^{FLEX} device.

Ordinary maintenance









CAUTION: The user is responsible for addressing to technicians for periodic maintenance.





User maintenance





CLEANING AND DISINFECTION BY THE USER



CAUTION: Do not sprays, liquids or foams directly onto any surface.

Device part	Operation	Instructions		
Bite block	Preparation	<p>Before each exam, the bite shall be covered with a new CE-marked* disposable sheaths. After each use, the sheath shall be disposed and the bite washed to remove any organic residue.</p> <p>Note*: If sold in other countries, the disposable sheaths must comply with local regulations.</p> <p> CAUTION! The bite is autoclavable for up to 100 sterilization cycles at 121°C and must be sterilized after each use. Alternatively, disposable protective covers must be used.</p>		
Parts in contact with the patient	Cleaning and Disinfection	After each exam, parts in contact with the patient shall be disinfected using approved chemical disinfectant.		
		<p><i>For the Bite Block and the Chinrest:</i></p>		
		<table border="1" style="width: 100%; border-collapse: collapse;"> <tr> <td style="text-align: center; vertical-align: middle;"></td> <td> <ul style="list-style-type: none"> ■ BePro disinfectant spray, ■ BePro disinfectant wipes, ■ BePro disinfectant concentrate. </td> </tr> <tr> <td style="text-align: center; vertical-align: middle;"></td> <td> <ul style="list-style-type: none"> ■ BePro disinfectant I, ■ BePro disinfectant R. </td> </tr> </table>		<ul style="list-style-type: none"> ■ BePro disinfectant spray, ■ BePro disinfectant wipes, ■ BePro disinfectant concentrate.
	<ul style="list-style-type: none"> ■ BePro disinfectant spray, ■ BePro disinfectant wipes, ■ BePro disinfectant concentrate. 			
	<ul style="list-style-type: none"> ■ BePro disinfectant I, ■ BePro disinfectant R. 			

Device part	Operation	Instructions	
Parts in contact with the patient	Cleaning and Disinfection	<i>For the Edentulous/TMJ support and the Temple supports</i>	
			<ul style="list-style-type: none"> ■ BePro disinfectant spray, ■ BePro disinfectant wipes, ■ BePro disinfectant concentrate.
			<ul style="list-style-type: none"> ■ BePro disinfectant I, ■ BePro disinfectant R.
Parts in contact with the patient	Cleaning and Disinfection	<i>For the patient handle</i>	
			<ul style="list-style-type: none"> ■ BePro disinfectant spray, ■ BePro disinfectant wipes, ■ BePro disinfectant concentrate.
			<ul style="list-style-type: none"> ■ BePro disinfectant I, ■ BePro disinfectant R.

Device part	Operation	Instructions	
External surfaces	Cleaning	External surfaces shall be regularly cleaned to remove dirt and disinfectant residue.	
			<ul style="list-style-type: none"> ■ BePro disinfectant spray ■ BePro disinfectant wipes ■ BePro disinfectant concentrate ■ BePro disinfectant I
			<ul style="list-style-type: none"> ■ BePro disinfectant R
External surfaces	Cleaning	<i>For the knob and the keyboard</i>	
			<ul style="list-style-type: none"> ■ BePro disinfectant R, ■ BePro disinfectant concentrate, ■ BePro disinfectant I
			<ul style="list-style-type: none"> ■ BePro disinfectant spray, ■ BePro disinfectant wipes.



CAUTION: Be aware that all the components shall be cleaned or disinfected, according to the table above, even during the first use of the device.

MAINTENANCE BY THE USER

The user is responsible for daily maintenance of the seethrough^{FLEX} device. In case of anomalies, contact the technician for fixing the issue.

Frequency	Operation
Daily	Visual inspection of the integrity of the device and workstation connecting cables.
	Visual inspection of the integrity of the covers and of all the parts of the device.
	Visual inspection of the status of the on-board control panel ("On-board control panel" on page 30).
	Visual inspection of the workstation functionality.
	Visual inspection of the movement fluidity of: <ul style="list-style-type: none"> ■ Rotation (see "Rotating core" on page 28). ■ Stand up/down (see "Visual inspection of movement fluidity" below). ■ X and Y axes (see "Visual inspection of movement fluidity" below).
When necessary	Call the technicians for periodic maintenance.

DAILY MAINTENANCE

Visual inspection of movement fluidity

Stand up/down

To check the movement upwards and downwards of the stand (see "Product description" on page 27), use the buttons on the on-board control panel (see "On-board control panel" on page 30).

Rotation and X and Y axes

- 1** Open the software seethrough studio and click on Start Acquisition (refer to seethrough studio Instructions of Use).
- 2** Select the **Scout** option.
- 3** Check that the rotation is performed without any problem.



4 When the scout images are shown on the screen, move the center of ROI both in the coronal and in the sagittal planes to force the movements of X and Y axes.

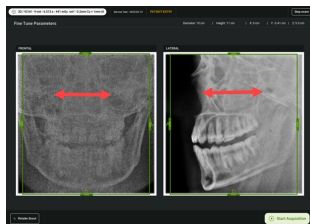

5 Before the exam starts, check that the center of rotation of the rotating core actually moved in the two directions.

7 After the check, cancel the current exam.

Disposal

DISPOSAL RESPONSIBILITY



- Separate the various components according to the materials they are made of.
- Drop the seethrough^{FLEX} device with a company that specializes on the recycling of related products.
- Do not abandon the seethrough^{FLEX} device in unsecured places.
- Always refer to current/applicable laws and rules in the country of use.

Apply the same instructions to disposal of all used consumable parts.

MATERIALS

The seethrough^{FLEX} device contains mainly the following materials to check all with technical documentation:

- Tube-head > dielectric oil, lead, copper, iron, aluminum, glass, tungsten and integrated electronic components.
- Column, rotating arm , extensions and covers> steel, lead, aluminum, polyurethane nonbiodegradable plastic material, collimation sheets, plastic loaded with carbon fibers, painted thermosetting plastic and integrated electronic components.
- Integrated electronic components: vetronite.
- Applied parts > non-biodegradable plastics, iron, aluminum and integrated electronic components.
- Other components: electric motors, cables, electric boards, plastic and rubber.
- Digital X-ray detector > iron, lead, copper, integrated electronic components.

WORKSTATION

Before disposing of the workstation, delete all the patient data from the hard disk. Use specific software for cleaning data from digital supports or physically destroy the hard disk.

Diagnostics

CONTENTS

This section deals with the following subjects:

Messages82

Messages

DESCRIPTION

Messages are due to device malfunction.

When a message is active, LEDs are yellow. An error message window pops up when the user select a new exam.



Notice: If the image quality of an examination is deemed unsatisfactory and/or there are inaccuracies, issues, or errors in the image reconstruction, please contact the technical service. In such cases, no specific error message is provided. The assessment must be conducted by a qualified professional. Particular attention should be paid to patient positioning, which is especially critical for 2D examinations.



CHECKS AND ACTIONS

Notice: For any error not listed in this table, call technical service.

Message codes depend on the type of error. The warning codes listed below indicate alerts within the workflow that the user can directly address. If an error code that is not included in this list appears, please contact the technical service.

	Device code	Code on the display	Description	Action
FOV_POSITION_NOT_ACHIEVABLE	1651	1651	motor error - hardware failure	The selected exam requires increasing the FOV beyond the maximum allowed value based on the room height. Please select a different exam or, if possible, have the patient sit to avoid collision with the room ceiling.
RX_TUBE_OVERHEATED	1701	101	device duty cycle limit reached	System overheating detected. Please wait the time reported before proceeding with the exam.
TUBE_HEAD_OVERHEATED	1702	101	device duty cycle limit reached	System overheating detected. Please wait the time reported before proceeding with the exam.
RXTUBE_AND_TUBEHEAD_OVERHEATED	1703	101	device duty cycle limit reached	System overheating detected. Please wait the time reported before proceeding with the exam

	Device code	Code on the display	Description	Action
RX_BUTTON_RELEASED	1802	102	operation interrupted	<p>The X-ray button has been released during the exam.</p> <ul style="list-style-type: none"> ■ If the release occurred accidentally, please evaluate the quality of the exam and, if necessary, reacquire it. <p> CAUTION!In case of exam repetition, evaluate the resultant exposure of the patient.</p> <ul style="list-style-type: none"> ■ If the button has never been released by the user, please contact the technical service.
RX_BUTTON_PRESSED	1803	106	operation interrupted	<p>The X-ray button has been pressed.</p> <ul style="list-style-type: none"> ■ If it was pressed accidentally, please re-start acquisition process. ■ If the button has never been pressed by the user, please contact the technical service.
DOOR_OPEN_DURING_EXAM	1804	1804	operation interrupted	<p>The door has been opened during the exam.</p> <ul style="list-style-type: none"> ■ If the opening occurred accidentally, please close the door, evaluate the quality of the exam and, if necessary, reacquire it. <p> CAUTION!In case of exam repetition, evaluate the resultant exposure of the patient.</p> <ul style="list-style-type: none"> ■ If the door has never been opened by the user or by the patient, please contact the technical service <p> CAUTION! In case of door opening, the exam immediately stops. Ensure safety of all users closing the door.</p>

	Device code	Code on the display	Description	Action
EMERGENCY_BUTTON_PRESSED	1805	1805	operation interrupted	<p>The Emergency stop button has been pressed.</p> <ul style="list-style-type: none"> ■ If this occurred accidentally, please turn OFF the device. Wait for 30 seconds, Turn ON the device. Restart the workstation. If the button was pressed during an exam, please also evaluate the quality of the exam and, if necessary, reacquire it. <p> CAUTION! In case of exam repetition, evaluate the resultant exposure of the patient.</p> <ul style="list-style-type: none"> ■ If the button has never been pressed by the user, please contact the technical service. <p> CAUTION! In case of actual emergency, ensure the safety of the patient and/or all the users within the area.</p>
INCOMPATIBLE_CHINREST_MOUNTED	1125	1125	wrong chinrest mounted	The mounted chinrest is not compatible with the selected exam. Please change the chinrest version to proceed with the acquisition.

Technical data

CONTENTS

This section deals with the following subjects:





List of available exams	86
Technical data	103
Dosimetry	108
Components, spare parts, consumables	134









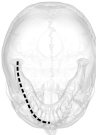

List of available exams





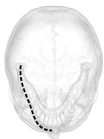





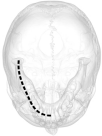



All FOV dimensions in the following tables are reported in centimeters and are based on an ADULT M size patient.

PANORAMIC EXAMS

Dental arch

Code	FoV (length x height)	Description	Reference
P1FULL	22x11	Full panoramic	 
P2FULL	23x11	Full panoramic ortho	
P1L	12x11	Left panoramic	 
P2L	12x11	Left panoramic ortho	
P1R	12x11	Right panoramic	 
P2R	12x11	Right panoramic ortho	

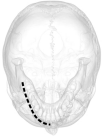

Code	FoV (length x height)	Description	Reference
P1UP	16x8	Upper panoramic	 
P2UP	15x8	Upper panoramic ortho	 
P1LO	16x7	Lower panoramic	 
P2LO	15x7	Lower panoramic ortho	 
P1UPL	9x8	Upper left panoramic	 
P2UPL	8x8	Upper left panoramic ortho	 
P1UPR	9x8	Upper right panoramic	
P2UPR	8x8	Upper right panoramic ortho	
P1LOL	9x7	Lower left panoramic	
P2LOL	8x7	Lower left panoramic ortho	

Code	FoV (length x height)	Description	Reference	
P1LOR	9x7	Lower right panoramic		
P2LOR	8x7	Lower right panoramic ortho		
P1NTM	16x11	Panoramic w/o TMJ		
P2NTM	15x11	Panoramic w/o TMJ ortho		
P1NTML	9x11	Left panoramic w/o TMJ		
P2NTML	8x11	Left panoramic w/o TMJ ortho		
P1NTMR	9x11	Right panoramic w/o TMJ		
P2NTMR	8x11	Right panoramic w/o TMJ ortho		

Bitewing

Code	FoV (length x height)	Description	Reference	
BWFULL	7x7 + 7x7	Full bitewing		
BWL	7x7	Left bitewing		
BWR	7x7	Right bitewing		

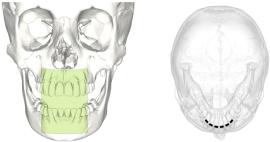





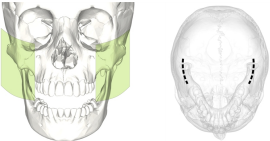
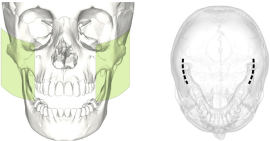

Incisors









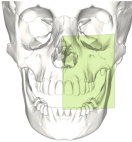

Code	FoV (length x height)	Description	Reference
P3FULL	7x7	Incisors (upper+lower)	
P3UP	7x4	Upper incisors	
P3LO	7x4	Lower incisors	

TMJ

Code	FoV (length x height)	Description	Reference
TMLL1	5x8 + 5x8	LL TMJ 2-view	
TMLL2	5x8 + 5x8	LL TMJ 4-view (open, closed mouth)	







Sinuses





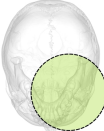

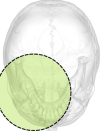

Code	FoV (length x height)	Description	Reference	
S1FULL	12x13	AP full sinuses		
S1L	6x13	AP left sinuses		
S1R	6x13	AP right sinuses		
S2MAX	12x7	AP maxillary sinuses		



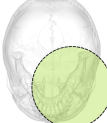

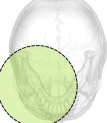

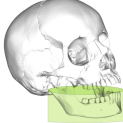
Code	FoV (length x height)	Description	Reference	
S2MAXL	6x7	AP left maxillary sinus		
S2MAXR	6x7	AP right maxillary sinus		
S3FR	12x7	AP frontal sinuses		
S3FRL	6x7	AP left frontal sinus		
S3FRR	6x7	AP right frontal sinus		

3D EXAMS









Dental arch











Code	FoV (length x height)	Description	Reference	
V1FULL	10x11	Full mouth		
V1L	9x11	Left arch (upper+lower)		
V1R	9x11	Right arch (upper+lower)		
V1UP	10x8	Upper jaw		

Code	FoV (length x height)	Description	Reference	
V1LO	10x8	Lower jaw		
V1UPL	8x8	Upper left jaw		
V1UPR	8x8	Upper right jaw		
V1LOL	8x6	Lower left jaw		
V1LOR	8x6	Lower right jaw		

Code	FoV (length x height)	Description	Reference	
V1NTM	9x10	Full mouth w/o TMJ		
V1NTML	8x10	Left arch (upper+lower) w/o TMJ		
V1NTMR	8x10	Right arch (upper+lower) w/o TMJ		

Molars/incisors

Code	FoV (length x height)	Description	Reference	
V2M0L	7x8	Left molars/premolars (upper+lower)		
V2M0R	7x8	Right molars/premolars (upper+lower)		
V2MUPL	7x5	Left upper molars/premolars		
V2MUPR	7x5	Right upper molars/premolars		





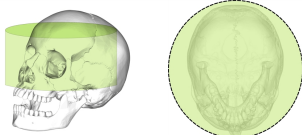
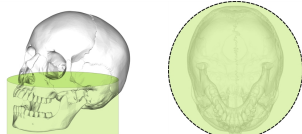

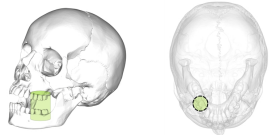

Code	FoV (length x height)	Description	Reference	
V2ML0L	7x5,5	Left lower molars/premolars		
V2ML0R	7x5,5	Right lower molars/premolars		
V2IN	5x8	Incisors/canine (upper+lower)		
V2INUP	5x5	Upper incisors/canine		
V2INLO	5x5,5	Lower incisors/canine		

Full head

Code	FoV (length x height)	Description	Reference
V3MXUP	14x10	Upper head	
V3MXLO	14x10	Lower head	

Individual teeth





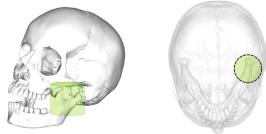
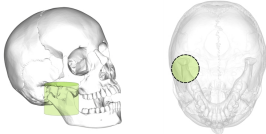

Code	FoV (length x height)	Description	Reference
V4ENDS	3x8	Endo S (upper+lower) incisors, canine, premolars	
V4ENDM	4x8	Endo M (upper+lower) molars	

Code	FoV (length x height)	Description	Reference	
V4ENDX	5x8	Endo multiple tooth (upper+lower) up to 3+3 teeth		
V4ES1	3x4	Endo S incisors, canine, premolars		
V4EM1	4x5	Endo M molars		
V4EX3	5x5	Endo multiple tooth only 3 teeth per arch		

TMJ

Code	FoV (length x height)	Description	Reference
V5TML	8x11	TMJ left single view	
V5TMR	8x11	TMJ right single view	

Sinuses

Code	FoV (length x height)	Description	Reference	
V6MX	10x8	Maxillary sinuses		
V6MXL	7,5x8	Left maxillary sinuses		
V6MXR	7,5x8	Right maxillary sinuses		

Airways/spine

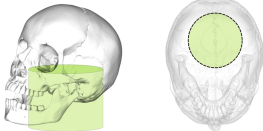
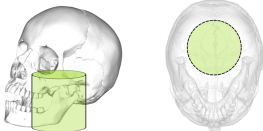
Code	FoV (length x height)	Description	Reference
V7AW	10x11	Airways view	
V8CV	10x11	Cervical vertebrae	

Technical data

POWER SUPPLY SYSTEM

Characteristic	Unit	Data
Nominal voltage	Vac	230 ± 10%
Number of phases		Monophase
Absorbed current	A	9.3 @ 230 Vac
Frequency	Hz	50/60
Power	kVA	2.1 kVA
Line resistance	Ω	≤1 @ 230

DUTY CYCLE

Worse case scenario

Exam type worst case	-	V3MXLO AL HD, 90 kV @ 8mA
Max thermal load	J	10368
Max Load	kV	88 @ 10 mA
Duty cycle* - Time ON (exposure time)	s	17,07
Duty cycle* - Time OFF (waiting time)	s	95

* It is possible to execute a sequence of 17 consecutive exams respecting the time OFF (between each exam with the same parameters) reported in the table. After the completion of this sequence, it is necessary to wait at least 800 seconds before executing one more exam (not a new sequence of exams). If the user wants to execute another sequence of 17 consecutive exams, it is necessary to wait the complete cooling of the device. In accordance with ANSI/AAMI ES60601-1 the device is classified as long time operation.

Normal use

Movement	-	All movements (column, rotating core)
Duty cycle* - Time ON (exposure time)	s	17.07
Duty cycle* - Time OFF (waiting time)	s	95

* It is possible to execute a sequence of 17 consecutive exams respecting the time OFF (between each exam with the same parameters) reported in the table. After the completion of this sequence, it is necessary to wait at least 800 seconds before executing one more exam (not a new sequence of exams). If the user wants to execute another sequence of 17 consecutive exams, it is necessary to wait the complete cooling of the device. In accordance with ANSI/AAMI ES60601-1 the device is classified as long time operation.

X-RAY TUBE

Nominal high tension (HT)	kV	110
Focal spot	mm	0.5
Max filament voltage	V	6.7
Max filament current	A	4.0
Anode material	Tungsten	
Anode angle	°	12
Anode head storage	kJ	30
Nominal anode power (@ 0.1 s)	W	1900
Continuous anode power (@ 75 kV, 4mA)	W	300
Manufacturer	-	CEI
Model	-	OPX/105-12

X-RAY TUBE HEAD

Dimensions	mm	240 x 186 x 108
Weight	kg	~8
Maximum HT	kV	105
Maximum anode current	mA	12

Inherent filtration	mmAl eq	2.5
Leakage @ 1m	mGy/h	< 1 (IEC 60601-1-3 p 12.4)
Manufacturer	-	W&H Sterilization Srl
Model	-	<ul style="list-style-type: none"> ■ ZZP.00.045.001 ■ S3730000

CENTRAL X-RAY BEAM AND ANODE ANGLE

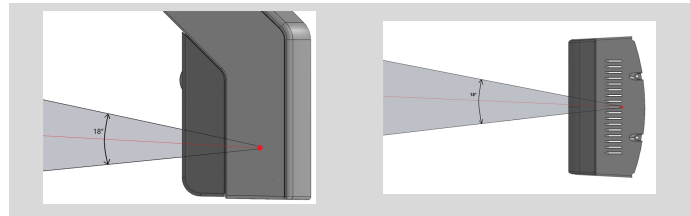

GEOMETRICAL RELATIONSHIP

Focal spot, beam cone, patient position and image-receiving area.

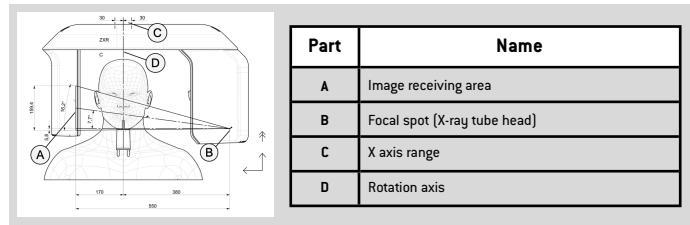

FILTRATION

Inherent filtration	mmAl eq	2.5 @ 70 kVp
Additional fixed filtration	mmAl eq	8.5 @ 70 kVp
Total filtration	mmAl eq	11 @ 70 kV
Filtration patient-detector	mmAl eq	0.3 @ 70 kV

RADIOLOGICAL PARAMETERS

HT inverter frequency	kHz	Variable with load
Ripple	%	< 4
Nominal high tension	kV	60 ÷ 90 ± 5%
Anode current	mA	4 ÷ 10 ± 5%

LASER CHARACTERISTICS

Safety	conformity to IEC 60825:2014	
Classification	Class 1M Laser	
Wavelength	nm	640
Maximum power output	mW	5

EXAM CHARACTERISTICS

Exam time (max)	sec	14	Panoramic - adults
		14	Panoramic - children
		14	3D - adults
		14	3D - children
		24	3D extended FOV - adults
		24	3D extended FOV - children
Image size	cm	30 x 11	Panoramic - adults
		25 x 9	Panoramic - children
		5 x 5 ÷ 10 x 11 adjustable ROI square/rectangular *	3D
		14 x 10	3D extended FOV
			3D Maximum FOV with stitching

* exams with a FOV smaller than 5 x 5 cm are optional.

X-RAY DETECTOR - PANO AND CBCT

Note: different X-ray detectors could be mounted on the device. Characteristics are reported below. With each X-ray detector, the same image quality is granted.

		A	B	C
Technology		TFT		
Active area dimensions	mm	155 x 155	159 x 159	153.6 x 153.6
Panoramic image matrix	pixel	1328 x 60 (16 bpp)	100 x 1516	1536 x 100
CBCT image matrix	pixel	1328 x 1308 (16 bpp)	1516 x 1516	1536 x 1536
Nominal pixel dimension	µm	120	105	100
Nominal spatial resolution	pl/mm	4	4.5	4
Grayscale	bits	16	16	16

ENVIRONMENTAL REQUIREMENTS

Working temperature	°C	5 ÷ 40
	°F	41 ÷ 104

Working relative humidity	%	Max. 80 up to 31 °C (88 °F), linearly decreasing to 50 at 40 °C (104 °F)
Storage and transport temperature	°C	-20 ÷ 60
	°F	-4 ÷ 140
Storage and transport relative humidity	%	0 ÷ 90
Atmospheric pressure	hPa	700 - 1060
Maximum temperature achievable by the applied part	°C	42
	°F	107,6

MECHANICAL CHARACTERISTICS

Foot print	mm	1010 x 1220
Weight	kg	120
Max column height	mm	2350
Column range	mm	750
Rotation range	°	>360
Min distance floor -chinrest	mm	1040
Max distance floor -chinrest	mm	1790

Patient LR axis range mm 60

Patient AP axis range mm 115

Chinrest - low mm 35

**Focus-to-detector distance
- PANO and CBCT** mm 550

Dosimetry

DAP VALUES

Values of Dose per Area Product (DAP) used to evaluate the radiation dose to the patient are reported in the tables below.

A tolerance of 50% must be taken into account.

To measure Air Kerma, the dosimetry probe was placed at the center of the detector area, stuck to the cover. No phantoms were placed in the device and the probe was fully irradiated during the entire duration of the procedure.

RADIOLOGICAL PARAMETERS

The radiological parameters are guaranteed to remain within the permitted range, in compliance with IEC 60601-2-63.

Maximum exposure time	16,94 s
Output linearity	Better than 0.2
Output reproducibility	Below 0.05

PANORAMIC EXPOSURE (2D) - CHILD (CH)

Dental arch

EXAM ID	EXAM DESCRIPTION	T exp (s)	LOW DOSE (LD)			NORMAL (NR)			HIGH QUALITY (HQ)		
			kV	mA	DAP (mGy*cm2)	kV	mA	DAP (mGy*cm2)	kV	mA	DAP (mGy*cm2)
P1FULL	Full panoramic	14,0	64	8	27	66	9	34	70	10	45
P1L	Left panoramic	8,0	64	8	16	66	9	20	70	10	26
P1R	Right panoramic	8,0	64	8	16	66	9	20	70	10	26
P1UP	Upper panoramic	11,7	64	8	18	66	9	22	70	10	29
P1LO	Lower panoramic	11,7	64	8	14	66	9	18	70	10	24
P1UPL	Upper left panoramic	6,9	64	8	10	66	9	13	70	10	17
P1UPR	Upper right panoramic	6,9	64	8	10	66	9	13	70	10	17
P1LOL	Lower left panoramic	6,9	64	8	8	66	9	11	70	10	14
P1LOR	Lower right panoramic	6,9	64	8	8	66	9	11	70	10	14
P1NTM	Panoramic w/o TMJ	11,7	64	8	23	66	9	29	70	10	38
P1NTML	Left panoramic w/o TMJ	6,9	64	8	14	66	9	17	70	10	23
P1NTMR	Right panoramic w/o TMJ	6,9	64	8	14	66	9	17	70	10	23
P2FULL	Full panoramic ortho	14,5	64	8	28	66	9	35	70	10	47
P2L	Left panoramic ortho	8,1	64	8	16	66	9	20	70	10	26
P2R	Right panoramic ortho	8,1	64	8	16	66	9	20	70	10	26
P2UP	Upper panoramic ortho	11,9	64	8	18	66	9	22	70	10	30
P2LO	Lower panoramic ortho	11,9	64	8	14	66	9	18	70	10	24
P2UPL	Upper left panoramic ortho	6,8	64	8	10	66	9	13	70	10	17
P2UPR	Upper right panoramic ortho	6,8	64	8	10	66	9	13	70	10	17
P2LOL	Lower left panoramic ortho	6,8	64	8	8	66	9	10	70	10	14
P2LOR	Lower right panoramic ortho	6,8	64	8	8	66	9	10	70	10	14
P2NTM	Panoramic w/o TMJ ortho	11,9	64	8	23	66	9	29	70	10	39
P2NTML	Left panoramic w/o TMJ ortho	6,8	64	8	13	66	9	17	70	10	22
P2NTMR	Right panoramic w/o TMJ ortho	6,8	64	8	13	66	9	17	70	10	22
P3FULL	Incisors (upper+lower)	6,5	70	8	11	72	9	14	76	10	18

P3UP	Upper incisors	6,5	70	8	7	72	9	8	76	10	11
P3LO	Lower incisors	6,5	70	8	7	72	9	8	76	10	11

Bitewing

EXAM ID	EXAM DESCRIPTION	T exp (s)	LOW DOSE (LD)			NORMAL (NR)			HIGH QUALITY (HQ)		
			kV	mA	DAP (mGy*cm2)	kV	mA	DAP (mGy*cm2)	kV	mA	DAP (mGy*cm2)
BWFULL	Full bitewing	9,1	64	8	12	66	9	16	70	10	21
BWL	Left bitewing	4,5	64	8	6	66	9	8	70	10	10
BWR	Right bitewing	4,5	64	8	6	66	9	8	70	10	10

TMJ

EXAM ID	EXAM DESCRIPTION	T exp (s)	LOW DOSE (LD)			NORMAL (NR)			HIGH QUALITY (HQ)		
			kV	mA	DAP (mGy*cm2)	kV	mA	DAP (mGy*cm2)	kV	mA	DAP (mGy*cm2)
TMLL1	LL TMK 2-view	8,5	68	9	15	70	10	18	74	10	22
TMLL2	LL TMJ 4-view (open, closed mouth)	16,9	68	9	30	70	10	37	74	10	44

Sinuses

EXAM ID	EXAM DESCRIPTION	T exp (s)	LOW DOSE (LD)			NORMAL (NR)			HIGH QUALITY (HQ)		
			kV	mA	DAP (mGy*cm2)	kV	mA	DAP (mGy*cm2)	kV	mA	DAP (mGy*cm2)
S1FULL	AP full sinuses	12,0	73	8	33	76	9	42	76	9	49
S1L	AP left sinuses	6,0	73	8	16	76	9	21	76	9	25
S1R	AP right sinuses	6,0	73	8	16	76	9	21	76	9	25
S2MAX	AP maxillary sinuses	12,0	73	8	22	76	9	28	76	9	33
S2MAXL	AP left maxillary sinus	6,0	73	8	11	76	9	14	76	9	16
S2MAXR	AP right maxillary sinus	6,0	73	8	11	76	9	14	76	9	16
S3FR	AP frontal sinuses	12,0	73	8	17	76	9	22	76	9	26
S3FRL	AP left frontal sinus	6,0	73	8	9	76	9	11	76	9	13
S3FRR	AP right frontal sinus	6,0	73	8	9	76	9	11	76	9	13

PANORAMIC EXPOSURE (2D) - ADULT S

Dental arch

EXAM ID	EXAM DESCRIPTION	T exp (s)	LOW DOSE (LD)			NORMAL (NR)			HIGH QUALITY (HQ)		
			kV	mA	DAP (mGy*cm2)	kV	mA	DAP (mGy*cm2)	kV	mA	DAP (mGy*cm2)
P1FULL	Full panoramic	14	64	9	38	66	10	46	72	10	60
P1L	Left panoramic	8	64	9	22	66	10	27	72	10	35
P1R	Right panoramic	8	64	9	22	66	10	27	72	10	35
P1UP	Upper panoramic	11,73	64	9	23	66	10	28	72	10	37
P1LO	Lower panoramic	11,73	64	9	19	66	10	24	72	10	31
P1UPL	Upper left panoramic	6,87	64	9	14	66	10	17	72	10	22
P1UPR	Upper right panoramic	6,87	64	9	14	66	10	17	72	10	22
P1LOL	Lower left panoramic	6,87	64	9	11	66	10	14	72	10	18
P1LOR	Lower right panoramic	6,87	64	9	11	66	10	14	72	10	18
P1NTM	Panoramic w/o TMJ	11,73	64	9	32	66	10	39	72	10	51
P1NTML	Left panoramic w/o TMJ	6,87	64	9	19	66	10	23	72	10	30
P1NTMR	Right panoramic w/o TMJ	6,87	64	9	19	66	10	23	72	10	30
P2FULL	Full panoramic ortho	14,5	64	9	39	66	10	48	72	10	62
P2L	Left panoramic ortho	8,09	64	9	22	66	10	27	72	10	35
P2R	Right panoramic ortho	8,09	64	9	22	66	10	27	72	10	35
P2UP	Upper panoramic ortho	11,85	64	9	23	66	10	29	72	10	37
P2LO	Lower panoramic ortho	11,85	64	9	19	66	10	24	72	10	31
P2UPL	Upper left panoramic ortho	6,76	64	9	14	66	10	17	72	10	22
P2UPR	Upper right panoramic ortho	6,76	64	9	14	66	10	17	72	10	22
P2LOL	Lower left panoramic ortho	6,76	64	9	11	66	10	14	72	10	18
P2LOR	Lower right panoramic ortho	6,76	64	9	11	66	10	14	72	10	18
P2NTM	Panoramic w/o TMJ ortho	11,85	64	9	32	66	10	40	72	10	52
P2NTML	Left panoramic w/o TMJ ortho	6,76	64	9	19	66	10	23	72	10	30
P2NTMR	Right panoramic w/o TMJ ortho	6,76	64	9	19	66	10	23	72	10	30
P3FULL	Incisors (upper+lower)	6,53	72	9	14	74	10	17	80	10	21

P3UP	Upper incisors	6,53	72	9	8	74	10	10	80	10	13
P3LO	Lower incisors	6,53	72	9	8	74	10	10	80	10	13

Bitewing

EXAM ID	EXAM DESCRIPTION	T exp (s)	LOW DOSE (LD)			NORMAL (NR)			HIGH QUALITY (HQ)		
			kV	mA	DAP (mGy*cm2)	kV	mA	DAP (mGy*cm2)	kV	mA	DAP (mGy*cm2)
BWFULL	Full bitewing	9,07	64	9	14	66	10	17	72	10	23
BWL	Left bitewing	4,53	64	9	7	66	10	9	72	10	11
BWR	Right bitewing	4,53	64	9	7	66	10	9	72	10	11

TMJ

EXAM ID	EXAM DESCRIPTION	T exp (s)	LOW DOSE (LD)			NORMAL (NR)			HIGH QUALITY (HQ)		
			kV	mA	DAP (mGy*cm2)	kV	mA	DAP (mGy*cm2)	kV	mA	DAP (mGy*cm2)
TMLL1	LL TMK 2-view	8,47	72	9	18	74	10	22	80	10	42
TMLL2	LL TMJ 4-view (open, closed mouth)	16,94	72	9	36	74	10	44	80	10	83

Sinuses

EXAM ID	EXAM DESCRIPTION	T exp (s)	LOW DOSE (LD)			NORMAL (NR)			HIGH QUALITY (HQ)		
			kV	mA	DAP (mGy*cm2)	kV	mA	DAP (mGy*cm2)	kV	mA	DAP (mGy*cm2)
S1FULL	AP full sinuses	12	74	9	47	80	10	66	80	10	77
S1L	AP left sinuses	6	74	9	23	80	10	33	80	10	39
S1R	AP right sinuses	6	74	9	23	80	10	33	80	10	39
S2MAX	AP maxillary sinuses	12	74	9	26	80	10	37	80	10	43
S2MAXL	AP left maxillary sinus	6	74	9	13	80	10	18	80	10	21
S2MAXR	AP right maxillary sinus	6	74	9	13	80	10	18	80	10	21
S3FR	AP frontal sinuses	12	74	9	24	80	10	34	80	10	40
S3FRL	AP left frontal sinus	6	74	9	12	80	10	17	80	10	20
S3FRR	AP right frontal sinus	6	74	9	12	80	10	17	80	10	20

PANORAMIC EXPOSURE (2D) - ADULT M

Dental arch

EXAM ID	EXAM DESCRIPTION	T exp (s)	LOW DOSE (LD)			NORMAL (NR)			HIGH QUALITY (HQ)		
			kV	mA	DAP (mGy*cm2)	kV	mA	DAP (mGy*cm2)	kV	mA	DAP (mGy*cm2)
P1FULL	Full panoramic	14	68	9	45	72	10	60	78	10	76
P1L	Left panoramic	8	68	9	26	72	10	35	78	10	44
P1R	Right panoramic	8	68	9	26	72	10	35	78	10	44
P1UP	Upper panoramic	11,73	68	9	28	72	10	37	78	10	47
P1LO	Lower panoramic	11,73	68	9	23	72	10	31	78	10	39
P1UPL	Upper left panoramic	6,87	68	9	16	72	10	22	78	10	28
P1UPR	Upper right panoramic	6,87	68	9	16	72	10	22	78	10	28
P1LOL	Lower left panoramic	6,87	68	9	14	72	10	18	78	10	23
P1LOR	Lower right panoramic	6,87	68	9	14	72	10	18	78	10	23
P1NTM	Panoramic w/o TMJ	11,73	68	9	39	72	10	51	78	10	65
P1NTML	Left panoramic w/o TMJ	6,87	68	9	23	72	10	30	78	10	38
P1NTMR	Right panoramic w/o TMJ	6,87	68	9	23	72	10	30	78	10	38
P2FULL	Full panoramic ortho	14,5	68	9	47	72	10	62	78	10	79
P2L	Left panoramic ortho	8,09	68	9	27	72	10	35	78	10	45
P2R	Right panoramic ortho	8,09	68	9	27	72	10	35	78	10	45
P2UP	Upper panoramic ortho	11,85	68	9	28	72	10	37	78	10	47
P2LO	Lower panoramic ortho	11,85	68	9	23	72	10	31	78	10	39
P2UPL	Upper left panoramic ortho	6,76	68	9	16	72	10	22	78	10	27
P2UPR	Upper right panoramic ortho	6,76	68	9	16	72	10	22	78	10	27
P2LOL	Lower left panoramic ortho	6,76	68	9	14	72	10	18	78	10	23
P2LOR	Lower right panoramic ortho	6,76	68	9	14	72	10	18	78	10	23
P2NTM	Panoramic w/o TMJ ortho	11,85	68	9	39	72	10	52	78	10	65
P2NTML	Left panoramic w/o TMJ ortho	6,76	68	9	23	72	10	30	78	10	38
P2NTMR	Right panoramic w/o TMJ ortho	6,76	68	9	23	72	10	30	78	10	38
P3FULL	Incisors (upper+lower)	6,53	76	9	16	80	10	21	86	10	27

P3UP	Upper incisors	6,53	76	9	10	80	10	13	86	10	16
P3LO	Lower incisors	6,53	76	9	10	80	10	13	86	10	16

Bitewing

EXAM ID	EXAM DESCRIPTION	T exp (s)	LOW DOSE (LD)			NORMAL (NR)			HIGH QUALITY (HQ)		
			kV	mA	DAP (mGy*cm2)	kV	mA	DAP (mGy*cm2)	kV	mA	DAP (mGy*cm2)
BWFULL	Full bitewing	9,07	68	9	17	72	10	23	78	10	29
BWL	Left bitewing	4,53	68	9	9	72	10	11	78	10	15
BWR	Right bitewing	4,53	68	9	9	72	10	11	78	10	15

TMJ

EXAM ID	EXAM DESCRIPTION	T exp (s)	LOW DOSE (LD)			NORMAL (NR)			HIGH QUALITY (HQ)		
			kV	mA	DAP (mGy*cm2)	kV	mA	DAP (mGy*cm2)	kV	mA	DAP (mGy*cm2)
TMLL1	LL TMK 2-view	8,47	78	10	26	84	10	32	86	10	34
TMLL2	LL TMJ 4-view (open, closed mouth)	16,94	78	10	51	84	10	64	86	10	69

Sinuses

EXAM ID	EXAM DESCRIPTION	T exp (s)	LOW DOSE (LD)			NORMAL (NR)			HIGH QUALITY (HQ)		
			kV	mA	DAP (mGy*cm2)	kV	mA	DAP (mGy*cm2)	kV	mA	DAP (mGy*cm2)
S1FULL	AP full sinuses	12	82	10	71	88	10	88	88	10	102
S1L	AP left sinuses	6	82	10	36	88	10	44	88	10	51
S1R	AP right sinuses	6	82	10	36	88	10	44	88	10	51
S2MAX	AP maxillary sinuses	12	82	10	39	88	10	49	88	10	57
S2MAXL	AP left maxillary sinus	6	82	10	20	88	10	24	88	10	28
S2MAXR	AP right maxillary sinus	6	82	10	20	88	10	24	88	10	28
S3FR	AP frontal sinuses	12	82	10	37	88	10	45	88	10	53
S3FRL	AP left frontal sinus	6	82	10	18	88	10	23	88	10	26
S3FRR	AP right frontal sinus	6	82	10	18	88	10	23	88	10	26

PANORAMIC EXPOSURE (2D) - ADULT L

Dental arch

EXAM ID	EXAM DESCRIPTION	T exp (s)	LOW DOSE (LD)			NORMAL (NR)			HIGH QUALITY (HQ)		
			kV	mA	DAP (mGy*cm2)	kV	mA	DAP (mGy*cm2)	kV	mA	DAP (mGy*cm2)
P1FULL	Full panoramic	14	72	9	53	78	10	75	82	10	87
P1L	Left panoramic	8	72	9	30	78	10	43	82	10	50
P1R	Right panoramic	8	72	9	30	78	10	43	82	10	50
P1UP	Upper panoramic	11,73	72	9	32	78	10	46	82	10	53
P1LO	Lower panoramic	11,73	72	9	27	78	10	38	82	10	44
P1UPL	Upper left panoramic	6,87	72	9	19	78	10	27	82	10	31
P1UPR	Upper right panoramic	6,87	72	9	19	78	10	27	82	10	31
P1LOL	Lower left panoramic	6,87	72	9	16	78	10	22	82	10	26
P1LOR	Lower right panoramic	6,87	72	9	16	78	10	22	82	10	26
P1NTM	Panoramic w/o TMJ	11,73	72	9	45	78	10	63	82	10	73
P1NTML	Left panoramic w/o TMJ	6,87	72	9	26	78	10	36	82	10	42
P1NTMR	Right panoramic w/o TMJ	6,87	72	9	26	78	10	36	82	10	42
P2FULL	Full panoramic ortho	14,5	72	9	55	78	10	77	82	10	90
P2L	Left panoramic ortho	8,09	72	9	31	78	10	44	82	10	50
P2R	Right panoramic ortho	8,09	72	9	31	78	10	44	82	10	50
P2UP	Upper panoramic ortho	11,85	72	9	33	78	10	46	82	10	53
P2LO	Lower panoramic ortho	11,85	72	9	27	78	10	38	82	10	44
P2UPL	Upper left panoramic ortho	6,76	72	9	19	78	10	27	82	10	31
P2UPR	Upper right panoramic ortho	6,76	72	9	19	78	10	27	82	10	31
P2LOL	Lower left panoramic ortho	6,76	72	9	16	78	10	22	82	10	26
P2LOR	Lower right panoramic ortho	6,76	72	9	16	78	10	22	82	10	26
P2NTM	Panoramic w/o TMJ ortho	11,85	72	9	45	78	10	64	82	10	74
P2NTML	Left panoramic w/o TMJ ortho	6,76	72	9	26	78	10	37	82	10	43
P2NTMR	Right panoramic w/o TMJ ortho	6,76	72	9	26	78	10	37	82	10	43
P3FULL	Incisors (upper+lower)	6,53	78	9	18	84	10	25	88	10	28

P3UP	Upper incisors	6,53	78	9	11	84	10	15	88	10	17
P3LO	Lower incisors	6,53	78	9	11	84	10	15	88	10	17

Bitewing

EXAM ID	EXAM DESCRIPTION	T exp (s)	LOW DOSE (LD)			NORMAL (NR)			HIGH QUALITY (HQ)		
			kV	mA	DAP (mGy*cm2)	kV	mA	DAP (mGy*cm2)	kV	mA	DAP (mGy*cm2)
BWFULL	Full bitewing	9,07	72	9	21	78	10	29	82	10	34
BWL	Left bitewing	4,53	72	9	10	78	10	15	82	10	17
BWR	Right bitewing	4,53	72	9	10	78	10	15	82	10	17

TMJ

EXAM ID	EXAM DESCRIPTION	T exp (s)	LOW DOSE (LD)			NORMAL (NR)			HIGH QUALITY (HQ)		
			kV	mA	DAP (mGy*cm2)	kV	mA	DAP (mGy*cm2)	kV	mA	DAP (mGy*cm2)
TMLL1	LL TMK 2-view	8,47	79	10	27	84	10	32	86	10	34
TMLL2	LL TMJ 4-view (open, closed mouth)	16,94	79	10	53	84	10	64	86	10	69

Sinuses

EXAM ID	EXAM DESCRIPTION	T exp (s)	LOW DOSE (LD)			NORMAL (NR)			HIGH QUALITY (HQ)		
			kV	mA	DAP (mGy*cm2)	kV	mA	DAP (mGy*cm2)	kV	mA	DAP (mGy*cm2)
S1FULL	AP full sinuses	12	84	10	77	88	10	88	88	10	102
S1L	AP left sinuses	6	84	10	38	88	10	44	88	10	51
S1R	AP right sinuses	6	84	10	38	88	10	44	88	10	51
S2MAX	AP maxillary sinuses	12	84	10	42	88	10	49	88	10	57
S2MAXL	AP left maxillary sinus	6	84	10	21	88	10	24	88	10	28
S2MAXR	AP right maxillary sinus	6	84	10	21	88	10	24	88	10	28
S3FR	AP frontal sinuses	12	84	10	39	88	10	45	88	10	53
S3FRL	AP left frontal sinus	6	84	10	20	88	10	23	88	10	26
S3FRR	AP right frontal sinus	6	84	10	20	88	10	23	88	10	26

3D EXPOSURE - CHILD (CH)

Dental arch

EXAM ID	EXAM DESCRIPTION	D FoV	H FoV	LD + LOW DEFINITION (LL)					NORMAL (NR)					HQ + HIGH DEFINITION (HD)				
				kV	mA	T Exp [s]	Air Kerma	DAP	kV	mA	T Exp [s]	Air Kerma	DAP	kV	mA	T Exp [s]	Air Kerma	DAP
				base	base	total	mGy	mGy*cm2	base	base	total	mGy	mGy*cm2	base	base	total	mGy	mGy*cm2
V1FULLEX	Full mouth extended	14	9	80	4	3,60	0,576	144	80	4	6,64	1,468	366	80	6	10,80	2,772	692
V1FULL	Full mouth	10	9	80	4	2,00	0,320	67	80	4	6,00	1,081	225	80	6	8,00	2,226	464
V1L	Left arc (upper+lower)	8	9	80	4	2,00	0,320	54	80	4	6,00	1,081	183	80	6	8,00	2,226	376
V1R	Right arc (upper+lower)	8	9	80	4	2,00	0,320	54	80	4	6,00	1,081	183	80	6	8,00	2,226	376
V1UP	Upper jaw	8	7	80	4	2,00	0,320	42	80	4	6,00	1,081	143	80	6	8,00	2,226	296
V1LO	Lower jaw	8	8	80	4	2,00	0,320	48	80	4	6,00	1,081	163	80	6	8,00	2,226	336
V1UPL	Upper left jaw	7	7	80	4	2,00	0,320	37	80	4	6,00	1,081	126	80	6	8,00	2,226	260
V1UPR	Upper right jaw	7	7	80	4	2,00	0,320	37	80	4	6,00	1,081	126	80	6	8,00	2,226	260
V1LOL	Lower left jaw	7	6	80	4	2,00	0,320	32	80	4	6,00	1,081	109	80	6	8,00	2,226	225
V1LOR	Lower right jaw	7	6	80	4	2,00	0,320	32	80	4	6,00	1,081	109	80	6	8,00	2,226	225
V1NTMEXT	Full mouth w/o TMJ extended	10	9	80	4	2,00	0,320	67	80	4	6,00	1,081	225	80	6	8,00	2,226	464
V1NTM	Full mouth w/o TMJ	8	9	80	4	2,00	0,320	54	80	4	6,00	1,081	183	80	6	8,00	2,226	376
V1NTML	Left arc (upper+lower) w/o TMJ	7	9	80	4	2,00	0,320	48	80	4	6,00	1,081	161	80	6	8,00	2,226	331
V1NTMR	Right arc (upper+lower) w/o TMJ	7	9	80	4	2,00	0,320	48	80	4	6,00	1,081	161	80	6	8,00	2,226	331
V2MOL	Left molars/premolars (upper+lower)	6	7	80	4	2,00	0,320	32	80	4	6,00	1,081	109	80	6	8,00	2,226	225
V2MOR	Right molars/premolars (upper+lower)	6	7	80	4	2,00	0,320	32	80	4	6,00	1,081	109	80	6	8,00	2,226	225
V2MUPL	Left upper molars/premolars	6	5	80	4	2,00	0,320	24	80	4	6,00	1,081	80	80	6	8,00	2,226	164
V2MUPR	Right upper molars/premolars	6	5	80	4	2,00	0,320	24	80	4	6,00	1,081	80	80	6	8,00	2,226	164
V2MLDL	Left lower molars/premolars	6	5	80	4	2,00	0,320	24	80	4	6,00	1,081	80	80	6	8,00	2,226	164
V2MLDR	Right lower molars/premolars	6	5	80	4	2,00	0,320	24	80	4	6,00	1,081	80	80	6	8,00	2,226	164
V2IN	Incisors/canine (upper+lower)	5	7	80	4	2,00	0,320	27	80	4	6,00	1,081	93	80	6	8,00	2,226	191
V2INUP	Upper incisors/canine	5	5	80	4	2,00	0,320	20	80	4	6,00	1,081	67	80	6	8,00	2,226	139
V2INLO	Lower incisors/canine	5	5	80	4	2,00	0,320	20	80	4	6,00	1,081	67	80	6	8,00	2,226	139

Maxillo

EXAM ID	EXAM DESCRIPTION	D FoV	H FoV	LD + LOW DEFINITION (LL)					NORMAL (NR)					HQ + HIGH DEFINITION (HD)				
				kV	mA	T Exp (s)	Air Kerma	DAP	kV	mA	T Exp (s)	Air Kerma	DAP	kV	mA	T Exp (s)	Air Kerma	DAP
				base	base	total	mGy	mGy*cm2	base	base	total	mGy	mGy*cm2	base	base	total	mGy	mGy*cm2
V3MXUP	Upper head	14	10	80	4	3,60	0,576	158	80	4	8,64	1,468	402	80	4	10,80	1,945	533
V3MXLO	Lower head	14	10	80	4	3,60	0,576	158	80	4	8,64	1,468	402	80	4	10,80	1,945	533

Endo/Teeth

EXAM ID	EXAM DESCRIPTION	D FoV	H FoV	LD + LOW DEFINITION (LL)					NORMAL (NR)					HQ + HIGH DEFINITION (HD)				
				kV	mA	T Exp (s)	Air Kerma	DAP	kV	mA	T Exp (s)	Air Kerma	DAP	kV	mA	T Exp (s)	Air Kerma	DAP
				base	base	total	mGy	mGy*cm2	base	base	total	mGy	mGy*cm2	base	base	total	mGy	mGy*cm2
V4ENDS	Endo S upper+lower (incisors, canine, premolars)	5	7	80	4	2,00	0,320	27	80	4	6,00	1,081	93	80	6	8,00	2,226	191
V4ENDM	Endo M upper+lower (molars)	5	7	80	4	2,00	0,320	27	80	4	6,00	1,081	93	80	6	8,00	2,226	191
V4ENDX	Endo multiple tooth upper+lower (upto 3+3 tooth)	5	7	80	4	2,00	0,320	27	80	4	6,00	1,081	93	80	6	8,00	2,226	191
V4ES1	Endo S (incisors, canine, premolars)	5	5	80	4	2,00	0,320	20	80	4	6,00	1,081	67	80	6	8,00	2,226	139
V4EM1	Endo M (molari)	5	5	80	4	2,00	0,320	20	80	4	6,00	1,081	67	80	6	8,00	2,226	139
V4EX3	Endo multiple tooth (upto 3 tooth)	5	5	80	4	2,00	0,320	20	80	4	6,00	1,081	67	80	6	8,00	2,226	139

TMJ

EXAM ID	EXAM DESCRIPTION	D FoV	H FoV	LD + LOW DEFINITION (LL)					NORMAL (NR)					HQ + HIGH DEFINITION (HD)				
				kV	mA	T Exp (s)	Air Kerma	DAP	kV	mA	T Exp (s)	Air Kerma	DAP	kV	mA	T Exp (s)	Air Kerma	DAP
				base	base	total	mGy	mGy*cm2	base	base	total	mGy	mGy*cm2	base	base	total	mGy	mGy*cm2
VSTML	TMJ left single view	6	9	80	4	2,00	0,320	41	80	4	6,00	1,081	139	80	6	8,00	2,226	287
VSTMR	TMJ right single view	6	9	80	4	2,00	0,320	41	80	4	6,00	1,081	139	80	6	8,00	2,226	287
VSTMDU	TMJ dual view (left/right)	10	9	80	4	2,00	0,320	67	80	4	6,00	1,081	225	80	6	8,00	2,226	464

Sinuses

EXAM ID	EXAM DESCRIPTION	D FoV	H FoV	LD + LOW DEFINITION (LL)					NORMAL (NR)					HQ + HIGH DEFINITION (HD)				
				kV	mA	T Exp (s)	Air Kerma	DAP	kV	mA	T Exp (s)	Air Kerma	DAP	kV	mA	T Exp (s)	Air Kerma	DAP
				base	base	total	mGy	mGy*cm2	base	base	total	mGy	mGy*cm2	base	base	total	mGy	mGy*cm2
V6MX	Maxillary sinuses	9	6	80	4	2,00	0,320	41	80	4	6,00	1,081	139	80	6	8,00	2,226	286
V6MXL	Left maxillary sinus	6,5	6	80	4	2,00	0,320	30	80	4	6,00	1,081	102	80	6	8,00	2,226	211
V6MXR	Right maxillary sinus	6,5	6	80	4	2,00	0,320	30	80	4	6,00	1,081	102	80	6	8,00	2,226	211

Airways

EXAM ID	EXAM DESCRIPTION	D FoV	H FoV	LD + LOW DEFINITION (LL)					NORMAL (NR)					HQ + HIGH DEFINITION (HD)				
				kV	mA	T Exp (s)	Air Kerma	DAP	kV	mA	T Exp (s)	Air Kerma	DAP	kV	mA	T Exp (s)	Air Kerma	DAP
				base	base	total	mGy	mGy*cm2	base	base	total	mGy	mGy*cm2	base	base	total	mGy	mGy*cm2
V7AW	Airways view	10	9	80	4	2,00	0,320	67	80	4	6,00	1,081	225	80	6	8,00	2,226	464

Spine

EXAM ID	EXAM DESCRIPTION	D FoV	H FoV	LD + LOW DEFINITION (LL)					NORMAL (NR)					HQ + HIGH DEFINITION (HD)				
				kV	mA	T Exp (s)	Air Kerma	DAP	kV	mA	T Exp (s)	Air Kerma	DAP	kV	mA	T Exp (s)	Air Kerma	DAP
				base	base	total	mGy	mGy*cm ²	base	base	total	mGy	mGy*cm ²	base	base	total	mGy	mGy*cm ²
V8CV	Cervical vertebrae	10	9	80	4	2,00	0,320	67	80	4	6,00	1,081	225	80	6	8,00	2,226	464

3D EXPOSURE - ADULT S

Dental arch

EXAM ID	EXAM DESCRIPTION	D FoV	H FoV	LD + LOW DEFINITION (LL)					NORMAL (NR)					HQ + HIGH DEFINITION (HD)				
				kV	mA	T Exp [s]	Air Kerma	DAP	kV	mA	T Exp [s]	Air Kerma	DAP	kV	mA	T Exp [s]	Air Kerma	DAP
				base	base	total	mGy	mGy*cm2	base	base	total	mGy	mGy*cm2	base	base	total	mGy	mGy*cm2
V1FULLEXT	Full mouth extended	14	10	85	4	3,60	0,672	184	80	5	6,64	1,753	480	80	?	10,80	3,139	859
V1FULL	Full mouth	10	11	85	4	2,00	0,374	95	80	5	6,00	1,310	332	80	?	8,00	2,549	646
V1L	Left arc (upper+lower)	9	11	85	4	2,00	0,374	86	80	5	6,00	1,310	300	80	?	8,00	2,549	584
V1R	Right arc (upper+lower)	9	11	85	4	2,00	0,374	86	80	5	6,00	1,310	300	80	?	8,00	2,549	584
V1UP	Upper jaw	10	8	85	4	2,00	0,374	70	80	5	6,00	1,310	244	80	?	8,00	2,549	475
V1LO	Lower jaw	10	6	85	4	2,00	0,374	53	80	5	6,00	1,310	186	80	?	8,00	2,549	362
V1UPL	Upper left jaw	8	8	85	4	2,00	0,374	56	80	5	6,00	1,310	198	80	?	8,00	2,549	385
V1UPR	Upper right jaw	8	8	85	4	2,00	0,374	56	80	5	6,00	1,310	198	80	?	8,00	2,549	385
V1LOL	Lower left jaw	8	6	85	4	2,00	0,374	43	80	5	6,00	1,310	151	80	?	8,00	2,549	293
V1LOR	Lower right jaw	8	6	85	4	2,00	0,374	43	80	5	6,00	1,310	151	80	?	8,00	2,549	293
V1NTMEXT	Full mouth w/o TMJ extended	11	10	85	4	2,00	0,374	93	80	5	6,00	1,310	327	80	?	8,00	2,549	636
V1NTM	Full mouth w/o TMJ	9	10	85	4	2,00	0,374	78	80	5	6,00	1,310	274	80	?	8,00	2,549	532
V1NTML	Left arc (upper+lower) w/o TMJ	8	10	85	4	2,00	0,374	70	80	5	6,00	1,310	245	80	?	8,00	2,549	476
V1NTMR	Right arc (upper+lower) w/o TMJ	8	10	85	4	2,00	0,374	70	80	5	6,00	1,310	245	80	?	8,00	2,549	476
V2MOL	Left molars/premolars (upper+lower)	7	8	85	4	2,00	0,374	50	80	5	6,00	1,310	174	80	?	8,00	2,549	339
V2MOR	Right molars/premolars (upper+lower)	7	8	85	4	2,00	0,374	50	80	5	6,00	1,310	174	80	?	8,00	2,549	339
V2MUPL	Left upper molars/premolars	7	5	85	4	2,00	0,374	32	80	5	6,00	1,310	111	80	?	8,00	2,549	217
V2MUPR	Right upper molars/premolars	7	5	85	4	2,00	0,374	32	80	5	6,00	1,310	111	80	?	8,00	2,549	217
V2MLDL	Left lower molars/premolars	7	5,5	85	4	2,00	0,374	35	80	5	6,00	1,310	122	80	?	8,00	2,549	237
V2MLDR	Right lower molars/premolars	7	5,5	85	4	2,00	0,374	35	80	5	6,00	1,310	122	80	?	8,00	2,549	237
V2IN	Incisors/canine (upper+lower)	5	8	85	4	2,00	0,374	36	80	5	6,00	1,310	128	80	?	8,00	2,549	248
V2INUP	Upper incisors/canine	5	5	85	4	2,00	0,374	23	80	5	6,00	1,310	82	80	?	8,00	2,549	159
V2INLO	Lower incisors/canine	5	5,5	85	4	2,00	0,374	25	80	5	6,00	1,310	89	80	?	8,00	2,549	174

Maxillo

EXAM ID	EXAM DESCRIPTION	D FoV	H FoV	LD + LOW DEFINITION (LL)					NORMAL (NR)					HQ + HIGH DEFINITION (HD)				
				kV	mA	T Exp (s)	Air Kerma	DAP	kV	mA	T Exp (s)	Air Kerma	DAP	kV	mA	T Exp (s)	Air Kerma	DAP
				base	base	total	mGy	mGy*cm2	base	base	total	mGy	mGy*cm2	base	base	total	mGy	mGy*cm2
V3MXUP	Upper head	14	10	85	4	3,60	0,672	184	80	4	8,64	1,468	402	80	6	10,80	2,772	759
V3MXLO	Lower head	14	10	85	4	3,60	0,672	184	80	4	8,64	1,468	402	80	6	10,80	2,772	759

Endo/Teeth

EXAM ID	EXAM DESCRIPTION	D FoV	H FoV	LD + LOW DEFINITION (LL)					NORMAL (NR)					HQ + HIGH DEFINITION (HD)				
				kV	mA	T Exp (s)	Air Kerma	DAP	kV	mA	T Exp (s)	Air Kerma	DAP	kV	mA	T Exp (s)	Air Kerma	DAP
				base	base	total	mGy	mGy*cm2	base	base	total	mGy	mGy*cm2	base	base	total	mGy	mGy*cm2
V4ENDS	Endo S upper+lower (incisors, canine, premolars)	5	8	85	4	2,00	0,374	36	80	5	6,00	1,310	128	80	7	8,00	2,549	248
V4ENDM	Endo M upper+lower (molars)	5	8	85	4	2,00	0,374	36	80	5	6,00	1,310	128	80	7	8,00	2,549	248
V4ENDX	Endo multiple tooth upper+lower (upto 3+3 tooth)	5	8	85	4	2,00	0,374	36	80	5	6,00	1,310	128	80	7	8,00	2,549	248
V4ES1	Endo S (incisors, canine, premolars)	5	5	85	4	2,00	0,374	23	80	5	6,00	1,310	82	80	7	8,00	2,549	159
V4EM1	Endo M (molari)	5	5	85	4	2,00	0,374	23	80	5	6,00	1,310	82	80	7	8,00	2,549	159
V4EX3	Endo multiple tooth (upto 3 tooth)	5	5	85	4	2,00	0,374	23	80	5	6,00	1,310	82	80	7	8,00	2,549	159

TMJ

EXAM ID	EXAM DESCRIPTION	D FoV	H FoV	LD + LOW DEFINITION (LL)					NORMAL (NR)					HQ + HIGH DEFINITION (HD)				
				kV	mA	T Exp (s)	Air Kerma	DAP	kV	mA	T Exp (s)	Air Kerma	DAP	kV	mA	T Exp (s)	Air Kerma	DAP
				base	base	total	mGy	mGy*cm2	base	base	total	mGy	mGy*cm2	base	base	total	mGy	mGy*cm2
VSTML	TMJ left single view	8	11	85	4	2,00	0,374	77	80	5	6,00	1,310	269	80	7	8,00	2,549	523
VSTMR	TMJ right single view	8	11	85	4	2,00	0,374	77	80	5	6,00	1,310	269	80	7	8,00	2,549	523
VSTMDU	TMJ dual view (left/right)	10	11	85	4	2,00	0,374	95	80	5	6,00	1,310	332	80	7	8,00	2,549	646

Sinuses

EXAM ID	EXAM DESCRIPTION	D FoV	H FoV	LD + LOW DEFINITION (LL)					NORMAL (NR)					HQ + HIGH DEFINITION (HD)				
				kV	mA	T Exp (s)	Air Kerma	DAP	kV	mA	T Exp (s)	Air Kerma	DAP	kV	mA	T Exp (s)	Air Kerma	DAP
				base	base	total	mGy	mGy*cm2	base	base	total	mGy	mGy*cm2	base	base	total	mGy	mGy*cm2
V6MX	Maxillary sinuses	10	8	85	4	2,00	0,374	70	80	5	6,00	1,310	244	80	7	8,00	2,549	475
V6MXL	Left maxillary sinus	7,5	8	85	4	2,00	0,374	53	80	5	6,00	1,310	186	80	7	8,00	2,549	361
V6MXR	Right maxillary sinus	7,5	8	85	4	2,00	0,374	53	80	5	6,00	1,310	186	80	7	8,00	2,549	361

Airways

EXAM ID	EXAM DESCRIPTION	D FoV	H FoV	LD + LOW DEFINITION (LL)					NORMAL (NR)					HQ + HIGH DEFINITION (HD)				
				kV	mA	T Exp (s)	Air Kerma	DAP	kV	mA	T Exp (s)	Air Kerma	DAP	kV	mA	T Exp (s)	Air Kerma	DAP
				base	base	total	mGy	mGy*cm2	base	base	total	mGy	mGy*cm2	base	base	total	mGy	mGy*cm2
V7AW	Airways view	10	11	85	4	2,00	0,374	95	80	5	6,00	1,310	332	80	7	8,00	2,549	646

Spine

EXAM ID	EXAM DESCRIPTION	D FoV	H FoV	LD + LOW DEFINITION (LL)					NORMAL (NR)					HQ + HIGH DEFINITION (HD)				
				kV	mA	T Exp (s)	Air Kerma	DAP	kV	mA	T Exp (s)	Air Kerma	DAP	kV	mA	T Exp (s)	Air Kerma	DAP
				base	base	total	mGy	mGy*cm ²	base	base	total	mGy	mGy*cm ²	base	base	total	mGy	mGy*cm ²
V8CV	Cervical vertebrae	10	11	85	4	2,00	0,374	95	80	5	6,00	1,310	332	80	7	8,00	2,549	646

3D EXPOSURE - ADULT M

Dental arch

EXAM ID	EXAM DESCRIPTION	D FoV	H FoV	LD + LOW DEFINITION (LL)					NORMAL (NR)					HQ + HIGH DEFINITION (HD)				
				kV	mA	T Exp [s]	Air Kerma	DAP	kV	mA	T Exp [s]	Air Kerma	DAP	kV	mA	T Exp [s]	Air Kerma	DAP
				base	base	total	mGy	mGy*cm2	base	base	total	mGy	mGy*cm2	base	base	total	mGy	mGy*cm2
V1FULLEXT	Full mouth extended	14	10	90	4	3,60	0,768	210	85	6	8,64	2,375	650	85	6	14,40	4,726	1.294
V1FULL	Full mouth	10	11	90	4	2,00	0,427	108	85	6	6,00	1,807	458	85	8	8,00	3,368	853
V1L	Left arc (upper+lower)	9	11	90	4	2,00	0,427	98	85	6	6,00	1,807	414	85	8	8,00	3,368	772
V1R	Right arc (upper+lower)	9	11	90	4	2,00	0,427	98	85	6	6,00	1,807	414	85	8	8,00	3,368	772
V1UP	Upper jaw	10	8	90	4	2,00	0,427	80	85	6	6,00	1,807	337	85	8	8,00	3,368	628
V1LO	Lower jaw	10	6	90	4	2,00	0,427	61	85	6	6,00	1,807	256	85	8	8,00	3,368	478
V1UPL	Upper left jaw	8	8	90	4	2,00	0,427	64	85	6	6,00	1,807	273	85	8	8,00	3,368	509
V1UPR	Upper right jaw	8	8	90	4	2,00	0,427	64	85	6	6,00	1,807	273	85	8	8,00	3,368	509
V1LOL	Lower left jaw	8	6	90	4	2,00	0,427	49	85	6	6,00	1,807	208	85	8	8,00	3,368	387
V1LOR	Lower right jaw	8	6	90	4	2,00	0,427	49	85	6	6,00	1,807	208	85	8	8,00	3,368	387
V1NTMEXT	Full mouth w/o TMJ extended	11	10	90	4	2,00	0,427	106	85	6	6,00	1,807	451	85	8	8,00	3,368	840
V1NTM	Full mouth w/o TMJ	9	10	90	4	2,00	0,427	89	85	6	6,00	1,807	377	85	8	8,00	3,368	703
V1NTML	Left arc (upper+lower) w/o TMJ	8	10	90	4	2,00	0,427	80	85	6	6,00	1,807	338	85	8	8,00	3,368	629
V1NTMR	Right arc (upper+lower) w/o TMJ	8	10	90	4	2,00	0,427	80	85	6	6,00	1,807	338	85	8	8,00	3,368	629
V2MOL	Left molars/premolars (upper+lower)	7	8	90	4	2,00	0,427	57	85	6	6,00	1,807	240	85	8	8,00	3,368	448
V2MOR	Right molars/premolars (upper+lower)	7	8	90	4	2,00	0,427	57	85	6	6,00	1,807	240	85	8	8,00	3,368	448
V2MUPL	Left upper molars/premolars	7	5	90	4	2,00	0,427	36	85	6	6,00	1,807	154	85	8	8,00	3,368	287
V2MUPR	Right upper molars/premolars	7	5	90	4	2,00	0,427	36	85	6	6,00	1,807	154	85	8	8,00	3,368	287
V2MLDL	Left lower molars/premolars	7	5,5	90	4	2,00	0,427	40	85	6	6,00	1,807	168	85	8	8,00	3,368	314
V2MLDR	Right lower molars/premolars	7	5,5	90	4	2,00	0,427	40	85	6	6,00	1,807	168	85	8	8,00	3,368	314
V2IN	Incisors/canine (upper+lower)	5	8	90	4	2,00	0,427	42	85	6	6,00	1,807	176	85	8	8,00	3,368	328
V2INUP	Upper incisors/canine	5	5	90	4	2,00	0,427	27	85	6	6,00	1,807	113	85	8	8,00	3,368	210
V2INLO	Lower incisors/canine	5	5,5	90	4	2,00	0,427	29	85	6	6,00	1,807	123	85	8	8,00	3,368	230

Maxillo

EXAM ID	EXAM DESCRIPTION	D FoV	H FoV	LD + LOW DEFINITION (LL)					NORMAL (NR)					HQ + HIGH DEFINITION (HD)				
				kV	mA	T Exp (s)	Air Kerma	DAP	kV	mA	T Exp (s)	Air Kerma	DAP	kV	mA	T Exp (s)	Air Kerma	DAP
				base	base	total	mGy	mGy*cm2	base	base	total	mGy	mGy*cm2	base	base	total	mGy	mGy*cm2
V3MXUP	Upper head	14	10	90	4	3,60	0,768	210	85	4	8,64	1,714	469	85	4	14,40	3,250	890
V3MXLO	Lower head	14	10	90	4	3,60	0,768	210	85	4	8,64	1,714	469	85	4	14,40	3,250	890

Endo/Teeth

EXAM ID	EXAM DESCRIPTION	D FoV	H FoV	LD + LOW DEFINITION (LL)					NORMAL (NR)					HQ + HIGH DEFINITION (HD)				
				kV	mA	T Exp (s)	Air Kerma	DAP	kV	mA	T Exp (s)	Air Kerma	DAP	kV	mA	T Exp (s)	Air Kerma	DAP
				base	base	total	mGy	mGy*cm2	base	base	total	mGy	mGy*cm2	base	base	total	mGy	mGy*cm2
V4ENDS	Endo S upper+lower (incisors, canine, premolars)	5	8	90	4	2,00	0,427	42	85	6	6,00	1,807	176	85	8	8,00	3,368	328
V4ENDM	Endo M upper+lower (molars)	5	8	90	4	2,00	0,427	42	85	6	6,00	1,807	176	85	8	8,00	3,368	328
V4ENDX	Endo multiple tooth upper+lower (upto 3+3 tooth)	5	8	90	4	2,00	0,427	42	85	6	6,00	1,807	176	85	8	8,00	3,368	328
V4ES1	Endo S (incisors, canine, premolars)	5	5	90	4	2,00	0,427	27	85	6	6,00	1,807	113	85	8	8,00	3,368	210
V4EM1	Endo M (molari)	5	5	90	4	2,00	0,427	27	85	6	6,00	1,807	113	85	8	8,00	3,368	210
V4EX3	Endo multiple tooth (upto 3 tooth)	5	5	90	4	2,00	0,427	27	85	6	6,00	1,807	113	85	8	8,00	3,368	210

TMJ

EXAM ID	EXAM DESCRIPTION	D FoV	H FoV	LD + LOW DEFINITION (LL)					NORMAL (NR)					HQ + HIGH DEFINITION (HD)				
				kV	mA	T Exp (s)	Air Kerma	DAP	kV	mA	T Exp (s)	Air Kerma	DAP	kV	mA	T Exp (s)	Air Kerma	DAP
				base	base	total	mGy	mGy*cm2	base	base	total	mGy	mGy*cm2	base	base	total	mGy	mGy*cm2
VSTML	TMJ left single view	8	11	90	4	2,00	0,427	87	85	6	6,00	1,807	370	85	8	8,00	3,368	691
VSTMR	TMJ right single view	8	11	90	4	2,00	0,427	87	85	6	6,00	1,807	370	85	8	8,00	3,368	691
VSTMDU	TMJ dual view (left/right)	10	11	90	4	2,00	0,427	108	85	6	6,00	1,807	458	85	8	8,00	3,368	853

Sinuses

EXAM ID	EXAM DESCRIPTION	D FoV	H FoV	LD + LOW DEFINITION (LL)					NORMAL (NR)					HQ + HIGH DEFINITION (HD)				
				kV	mA	T Exp (s)	Air Kerma	DAP	kV	mA	T Exp (s)	Air Kerma	DAP	kV	mA	T Exp (s)	Air Kerma	DAP
				base	base	total	mGy	mGy*cm2	base	base	total	mGy	mGy*cm2	base	base	total	mGy	mGy*cm2
V6MX	Maxillary sinuses	10	8	90	4	2,00	0,427	80	85	6	6,00	1,807	337	85	8	8,00	3,368	628
V6MXL	Left maxillary sinus	7,5	8	90	4	2,00	0,427	61	85	6	6,00	1,807	256	85	8	8,00	3,368	478
V6MXR	Right maxillary sinus	7,5	8	90	4	2,00	0,427	61	85	6	6,00	1,807	256	85	8	8,00	3,368	478

Airways

EXAM ID	EXAM DESCRIPTION	D FoV	H FoV	LD + LOW DEFINITION (LL)					NORMAL (NR)					HQ + HIGH DEFINITION (HD)				
				kV	mA	T Exp (s)	Air Kerma	DAP	kV	mA	T Exp (s)	Air Kerma	DAP	kV	mA	T Exp (s)	Air Kerma	DAP
				base	base	total	mGy	mGy*cm2	base	base	total	mGy	mGy*cm2	base	base	total	mGy	mGy*cm2
V7AW	Airways view	10	11	90	4	2,00	0,427	108	85	6	6,00	1,807	458	85	8	8,00	3,368	853

Spine

EXAM ID	EXAM DESCRIPTION	D FoV	H FoV	LD + LOW DEFINITION (LL)					NORMAL (NR)					HQ + HIGH DEFINITION (HD)				
				kV	mA	T Exp (s)	Air Kerma	DAP	kV	mA	T Exp (s)	Air Kerma	DAP	kV	mA	T Exp (s)	Air Kerma	DAP
				base	base	total	mGy	mGy*cm ²	base	base	total	mGy	mGy*cm ²	base	base	total	mGy	mGy*cm ²
V8CV	Cervical vertebrae	10	11	90	4	2,00	0,427	108	85	6	6,00	1,807	458	85	8	8,00	3,368	853

3D EXPOSURE - ADULT L

Dental arch

EXAM ID	EXAM DESCRIPTION	D FoV	H FoV	LD + LOW DEFINITION (LL)					NORMAL (NR)					HQ + HIGH DEFINITION (HD)				
				kV	mA	T Exp [s]	Air Kerma	DAP	kV	mA	T Exp [s]	Air Kerma	DAP	kV	mA	T Exp [s]	Air Kerma	DAP
				base	base	total	mGy	mGy*cm2	base	base	total	mGy	mGy*cm2	base	base	total	mGy	mGy*cm2
V1FULLEXT	Full mouth extended	14	10	90	4	3,60	0,768	210	85	?	6,64	2,658	728	85	?	14,40	5,408	1.481
V1FULL	Full mouth	10	11	90	5	2,00	0,498	126	85	?	6,00	2,046	518	85	10	8,00	3,982	1.009
V1L	Left arc (upper+lower)	9	11	90	5	2,00	0,498	114	85	?	6,00	2,046	469	85	10	8,00	3,982	913
V1R	Right arc (upper+lower)	9	11	90	5	2,00	0,498	114	85	?	6,00	2,046	469	85	10	8,00	3,982	913
V1UP	Upper jaw	10	8	90	5	2,00	0,498	93	85	?	6,00	2,046	382	85	10	8,00	3,982	743
V1LO	Lower jaw	10	6	90	5	2,00	0,498	71	85	?	6,00	2,046	290	85	10	8,00	3,982	565
V1UPL	Upper left jaw	8	8	90	5	2,00	0,498	75	85	?	6,00	2,046	309	85	10	8,00	3,982	601
V1UPR	Upper right jaw	8	8	90	5	2,00	0,498	75	85	?	6,00	2,046	309	85	10	8,00	3,982	601
V1LOL	Lower left jaw	8	6	90	5	2,00	0,498	57	85	?	6,00	2,046	235	85	10	8,00	3,982	457
V1LOR	Lower right jaw	8	6	90	5	2,00	0,498	57	85	?	6,00	2,046	235	85	10	8,00	3,982	457
V1NTMEXT	Full mouth w/o TMJ extended	11	10	90	5	2,00	0,498	124	85	?	6,00	2,046	510	85	10	8,00	3,982	993
V1NTM	Full mouth w/o TMJ	9	10	90	5	2,00	0,498	104	85	?	6,00	2,046	427	85	10	8,00	3,982	831
V1NTML	Left arc (upper+lower) w/o TMJ	8	10	90	5	2,00	0,498	93	85	?	6,00	2,046	382	85	10	8,00	3,982	744
V1NTMR	Right arc (upper+lower) w/o TMJ	8	10	90	5	2,00	0,498	93	85	?	6,00	2,046	382	85	10	8,00	3,982	744
V2MOL	Left molars/premolars (upper+lower)	?	8	90	5	2,00	0,498	66	85	?	6,00	2,046	272	85	10	8,00	3,982	529
V2MOR	Right molars/premolars (upper+lower)	?	8	90	5	2,00	0,498	66	85	?	6,00	2,046	272	85	10	8,00	3,982	529
V2MUPL	Left upper molars/premolars	?	5	90	5	2,00	0,498	42	85	?	6,00	2,046	174	85	10	8,00	3,982	339
V2MUPR	Right upper molars/premolars	?	5	90	5	2,00	0,498	42	85	?	6,00	2,046	174	85	10	8,00	3,982	339
V2MLDL	Left lower molars/premolars	?	5,5	90	5	2,00	0,498	46	85	?	6,00	2,046	191	85	10	8,00	3,982	371
V2MLDR	Right lower molars/premolars	?	5,5	90	5	2,00	0,498	46	85	?	6,00	2,046	191	85	10	8,00	3,982	371
V2IN	Incisors/canine (upper+lower)	5	8	90	5	2,00	0,498	49	85	?	6,00	2,046	199	85	10	8,00	3,982	388
V2INUP	Upper incisors/canine	5	5	90	5	2,00	0,498	31	85	?	6,00	2,046	128	85	10	8,00	3,982	248
V2INLO	Lower incisors/canine	5	5,5	90	5	2,00	0,498	34	85	?	6,00	2,046	140	85	10	8,00	3,982	272

Maxillo

EXAM ID	EXAM DESCRIPTION	D FoV	H FoV	LD + LOW DEFINITION (LL)					NORMAL (NR)					HQ + HIGH DEFINITION (HD)				
				kV	mA	T Exp (s)	Air Kerma	DAP	kV	mA	T Exp (s)	Air Kerma	DAP	kV	mA	T Exp (s)	Air Kerma	DAP
				base	base	total	mGy	mGy*cm2	base	base	total	mGy	mGy*cm2	base	base	total	mGy	mGy*cm2
V3MXUP	Upper head	14	10	90	5	3,60	0,897	246	85	5	8,64	2,044	560	85	5	14,40	3,989	1.092
V3MXLO	Lower head	14	10	90	5	3,60	0,897	246	85	5	8,64	2,044	560	85	5	14,40	3,989	1.092

Endo/Teeth

EXAM ID	EXAM DESCRIPTION	D FoV	H FoV	LD + LOW DEFINITION (LL)					NORMAL (NR)					HQ + HIGH DEFINITION (HD)				
				kV	mA	T Exp (s)	Air Kerma	DAP	kV	mA	T Exp (s)	Air Kerma	DAP	kV	mA	T Exp (s)	Air Kerma	DAP
				base	base	total	mGy	mGy*cm2	base	base	total	mGy	mGy*cm2	base	base	total	mGy	mGy*cm2
V4ENDS	Endo S upper+lower (incisors, canine, premolars)	5	8	90	5	2,00	0,498	49	85	7	6,00	2,046	199	85	10	8,00	3,982	388
V4ENDM	Endo M upper+lower (molars)	5	8	90	5	2,00	0,498	49	85	7	6,00	2,046	199	85	10	8,00	3,982	388
V4ENDX	Endo multiple tooth upper+lower (upto 3+3 tooth)	5	8	90	5	2,00	0,498	49	85	7	6,00	2,046	199	85	10	8,00	3,982	388
V4ES1	Endo S (incisors, canine, premolars)	5	5	90	5	2,00	0,498	31	85	7	6,00	2,046	128	85	10	8,00	3,982	248
V4EM1	Endo M (molari)	5	5	90	5	2,00	0,498	31	85	7	6,00	2,046	128	85	10	8,00	3,982	248
V4EX3	Endo multiple tooth (upto 3 tooth)	5	5	90	5	2,00	0,498	31	85	7	6,00	2,046	128	85	10	8,00	3,982	248

TMJ

EXAM ID	EXAM DESCRIPTION	D FoV	H FoV	LD + LOW DEFINITION (LL)					NORMAL (NR)					HQ + HIGH DEFINITION (HD)				
				kV	mA	T Exp (s)	Air Kerma	DAP	kV	mA	T Exp (s)	Air Kerma	DAP	kV	mA	T Exp (s)	Air Kerma	DAP
				base	base	total	mGy	mGy*cm2	base	base	total	mGy	mGy*cm2	base	base	total	mGy	mGy*cm2
VSTML	TMJ left single view	8	11	90	5	2,00	0,498	102	85	7	6,00	2,046	420	85	10	8,00	3,982	816
VSTMR	TMJ right single view	8	11	90	5	2,00	0,498	102	85	7	6,00	2,046	420	85	10	8,00	3,982	816
VSTMDU	TMJ dual view (left/right)	10	11	90	5	2,00	0,498	126	85	7	6,00	2,046	518	85	10	8,00	3,982	1.009

Sinuses

EXAM ID	EXAM DESCRIPTION	D FoV	H FoV	LD + LOW DEFINITION (LL)					NORMAL (NR)					HQ + HIGH DEFINITION (HD)				
				kV	mA	T Exp (s)	Air Kerma	DAP	kV	mA	T Exp (s)	Air Kerma	DAP	kV	mA	T Exp (s)	Air Kerma	DAP
				base	base	total	mGy	mGy*cm2	base	base	total	mGy	mGy*cm2	base	base	total	mGy	mGy*cm2
V6MX	Maxillary sinuses	10	8	90	5	2,00	0,498	93	85	7	6,00	2,046	382	85	10	8,00	3,982	743
V6MXL	Left maxillary sinus	7,5	8	90	5	2,00	0,498	71	85	7	6,00	2,046	290	85	10	8,00	3,982	565
V6MXR	Right maxillary sinus	7,5	8	90	5	2,00	0,498	71	85	7	6,00	2,046	290	85	10	8,00	3,982	565

Airways

EXAM ID	EXAM DESCRIPTION	D FoV	H FoV	LD + LOW DEFINITION (LL)					NORMAL (NR)					HQ + HIGH DEFINITION (HD)				
				kV	mA	T Exp (s)	Air Kerma	DAP	kV	mA	T Exp (s)	Air Kerma	DAP	kV	mA	T Exp (s)	Air Kerma	DAP
				base	base	total	mGy	mGy*cm2	base	base	total	mGy	mGy*cm2	base	base	total	mGy	mGy*cm2
V7AW	Airways view	10	11	90	5	2,00	0,498	126	85	7	6,00	2,046	518	85	10	8,00	3,982	1.009

Spine

EXAM ID	EXAM DESCRIPTION	D FoV	H FoV	LD + LOW DEFINITION (LL)					NORMAL (NR)					HQ + HIGH DEFINITION (HD)				
				kV	mA	T Exp (s)	Air Kerma	DAP	kV	mA	T Exp (s)	Air Kerma	DAP	kV	mA	T Exp (s)	Air Kerma	DAP
				base	base	total	mGy	mGy*cm ²	base	base	total	mGy	mGy*cm ²	base	base	total	mGy	mGy*cm ²
V8CV	Cervical vertebrae	10	11	90	5	2,00	0,498	126	85	7	6,00	2,046	518	85	10	8,00	3,982	1.009

EXAM FILTRATION

Exam type	Inherent filtration	Fixed filtration	Additional filtration	Total filtration
Panoramic exposure (2D) and 3D exposure	2.5 mm Al	8.5 mm Al	-	11 mm Al

METHOD FOR CALCULATING DAP



The total DAP for a 2D or a 3D exam is computed as the product of the irradiated area in cm² and the air kerma, both measured on the sensor plane:





$$DAP = AirKerma * XrayArea_{cm^2}$$



The value of the Air Kerma at sensor level is measured with a dosimetry probe, placed at the center of the detector area, stuck to the cover, with collimators wide open.

Components, spare parts, consumables

LIST OF COMPONENTS AND SPARE PARTS seethrough^{FLEX}

Picture	Part	Part number
	Bite block (10 pcs)	19740018
	Edentulous/TMJ support	19740021

Picture	Part	Part number
	Chinrest	19740019
	Chinrest - low	19740020
	Temple support- right	19740022
	Temple support - left	19740023

Picture	Part	Part number
	Temple support pad (2 pcs)	19740024
	Mobile X-ray command (chord + command – no wall holder)	X056036X

Authorized W&H service partners

Find your nearest service partner at www.wh.com.

*In memory of Simona, whose work and
dedication were essential to the
development of this product.*

Thanks Simona



 **W&H Sterilization Srl**

via Bolgara, 2
Brusaporto (BG) - 24060
Italy
www.wh.com
+39 035 66 63 000

XRE-200
Instructions for Use
ENG
Rev02
09/02/2026
Subject to changes

Type: XRE-200

Valid edition of the Instructions for Use: Rev02 of 09/02/2026

If you do not have this edition, you can obtain it free of charge:

- At the www.wh.com website.
- By calling up the phone number of your authorized W&H service partners, see "Authorized W&H service partners" on page 136
- By scanning the following 2D code

